

DESIGN
FOR
BATHROOM

THAI

Lavanderie



RAB

06. Sistemi di apertura
Opening systems

101. Accessori
Accessories

111. Materiali e finiture
Materials and finishes

RAB

Tante soluzioni salvaspazio per organizzare al meglio la lavanderia domestica

A host of space-saving ideas for organising a home laundry

Predisporre un ambiente dedicato alla lavanderia, che si tratti di un ripostiglio, di un corridoio o di un antibagno, significa organizzare lo spazio utile attraverso elementi contenitori nei quali riordinare tutto il necessario.

Equipping a room as a laundry, be it a box room, corridor or bathroom vestibule, means organising space with the use of container units to hold everything needed.

Créer un espace dédié à la buanderie, qu'il s'agisse d'un placard, d'un couloir ou d'un dressing, cela signifie organiser l'espace utile à travers des éléments de rangement dans lesquels ranger tout le nécessaire.

Die Einrichtung eines Raums als Waschküche, sei es ein Abstellraum, ein Flur oder ein Vorraum eines Badzimmers, bedeutet den Nutzraum durch Stauraumelemente so zu organisieren, dass alles Notwendige darin untergebracht werden kann.

01



02



04



05



FOCUS

01. ARMADIATURE
Cupboards

02. STRUTTURE A GIORNO
Open structures

03. STRUTTURE A GIORNO DOPPIE
Double open structures

04. PANCHE PER LAVANDERIA
Laundry benches

05. BASI A GIORNO PER LAVANDERIA
Laundry base units

06. MENSOLE
Shelves

07. ACCESSORI E ATTREZZATURE
Accessories and fittings

03



06

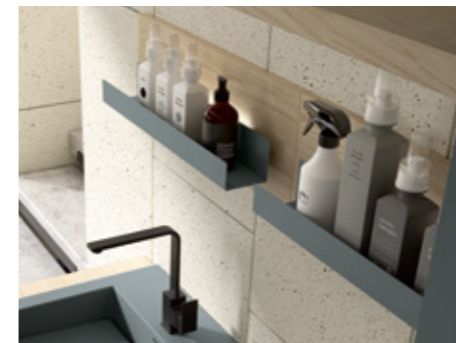

07



Lavatrice, asciugatrice e lavatoio guidano il progetto a soluzioni funzionali e salvaspazio

Washing machine, dryer and washtub are the guiding features for a functional, space-saving project

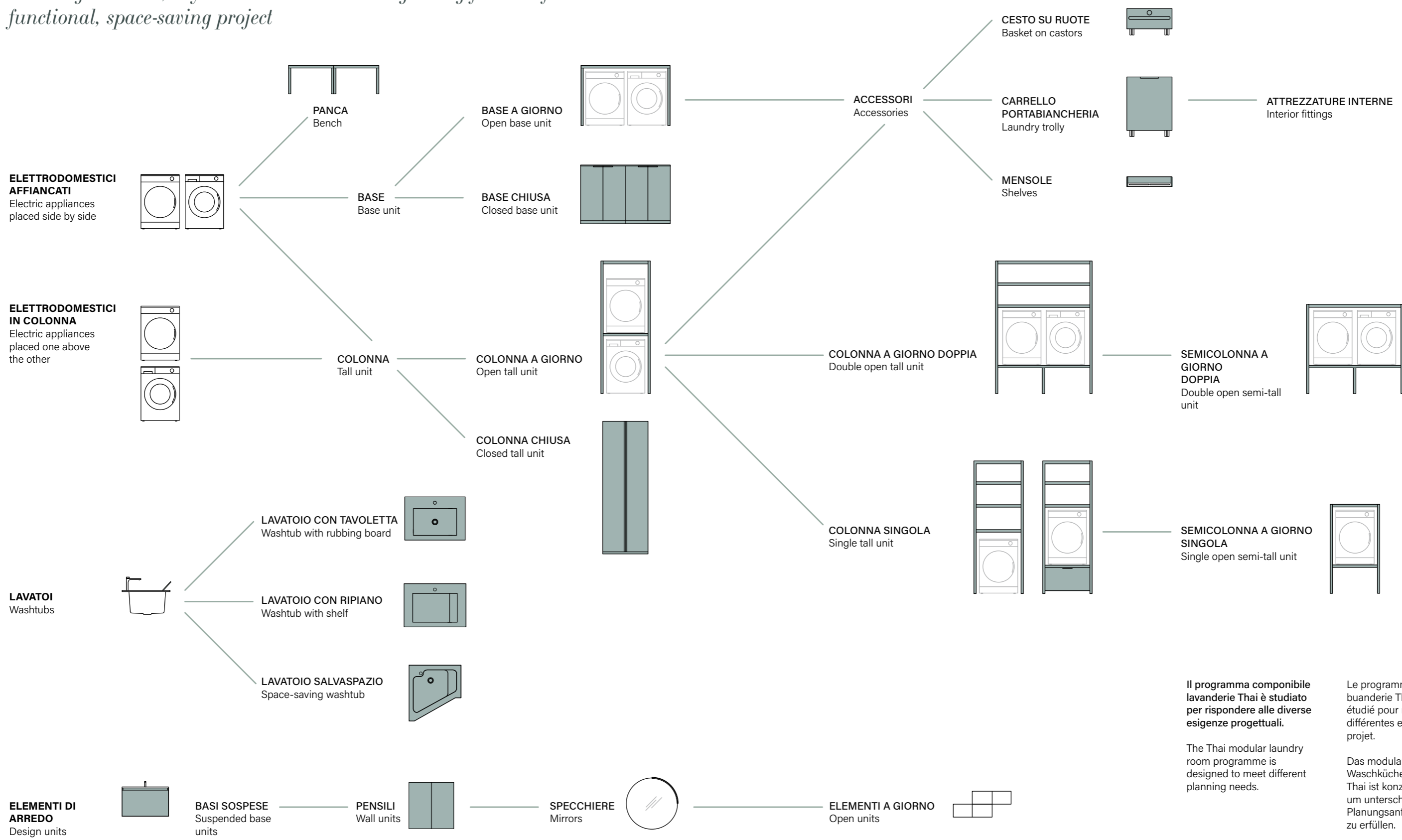

Il programma componibile lavanderie Thai è studiato per rispondere alle diverse esigenze progettuali.

The Thai modular laundry room programme is designed to meet different planning needs.

Le programme modulaire buanderie Thai est étudié pour répondre aux différentes exigences de projet.

Das modulare Waschküchenprogramm Thai ist konzipiert, um unterschiedliche Planungsanforderungen zu erfüllen.

Una lavanderia accogliente e personalizzabile attraverso maniglie e numerosi materiali

A cosy laundry space that can be customised by the use of different handles and materials



THAI MANIGLIA
Handle / Poignée / Griff

Maniglia in metallo finitura Argento, Titanio, Nero, Bronzo o Ottone.

Handle in Argento, Titanio, Nero, Bronzo or Ottone painted metal.
Poignée en métal verni Argento, Titanio, Nero, Bronzo ou Ottone.
Griff aus Argento, Titanio, Nero, Bronzo oder Ottone lackiertem Metall.



THAI LINE
Line Handle / Line Poignée / Line Griff

Maniglia in metallo finitura Argento. Disponibile su richiesta nelle finiture laccate.

Handle in Argento painted metal. Available upon request in lacquered finishes.
Poignée en métal verni Argento. Disponible sur demande dans les finitions laquées.
Griff aus Argento lackiertem Metall. Auf Anfrage in lackierten Ausführungen erhältlich.



THAI PRESA DIRETTA
Grip Opening / Poignée à Prise Directe / Direktgriff

Maniglia in metallo verniciato Argento, Titanio, Nero, Bronzo o Ottone.

Handle in Argento, Titanio, Nero, Bronzo or Ottone painted metal.
Poignée en métal verni Argento, Titanio, Nero, Bronzo ou Ottone.
Griff aus Argento, Titanio, Nero, Bronzo oder Ottone lackiertem Metall.



THAI GOLA
Grip Profile / Gorge / Griffprofil

Gola in metallo verniciato Argento, Titanio, Nero, Bronzo o Ottone. Disponibili anche in tutti i colori laccati.

Grip Profile in Argento, Titanio, Nero, Bronzo or Ottone painted metal. Also available in all lacquered colours.
Gorge en métal verni Argento, Titanio, Nero, Bronzo ou Ottone. Disponibles aussi dans toutes les couleurs laquées.
Griffprofil aus Argento lackiertem Metall. Auf Anfrage auch in allen lackierten Ausführungen erhältlich.

LE FINITURE FINISHES

Per le strutture a giorno abbiamo selezionato i materiali più adatti ad un ambiente umido. Le finiture di superficie riproducono un gran numero di materiali dal legno alla pietra.

For open units we have selected materials that are not affected by a damp environment.

The surface finishes reproduce a host of materials, from wood to stone.

Pour les structures ouvertes, nous avons sélectionné les matériaux les plus adaptés à un environnement humide. Les finitions de surface reproduisent un grand nombre de matériaux, allant du bois à la pierre.

Für die offenen Strukturen haben wir Materialien ausgewählt, die sich am besten für einen Feuchtraum eignen. Die Oberflächenausführungen sind einer Vielzahl von Materialien nachempfunden, von Holz bis Stein.

Finiture strutture a giorno sp. 3,8 cm
Finishes for open structure th. 3,8 cm

Finiture scocche e frontali
Carcase and front finishes

20 MATERICI



Finiture pag. 114

52 LACCATI Opachi



Finiture pag. 111

52 LACCATI Lucidi



Finiture pag. 111

52 LACCATI Touch



Finiture pag. 111



Scocca e frontali
Carcases and fronts

Strutture a giorno
Open structures

4 MATERICI



Malta



Rovere Chiaro

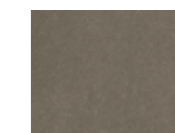

Roccia



Cannella

12 HPL

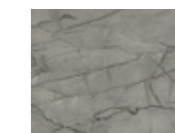

Finiture pag. 113

52 LACCATI Opachi



Finiture pag. 111

52 LACCATI Lucidi



Finiture pag. 111



TUTTI I COLORI A PAGINA 111 ALL COLOURS AT PAGE 111

FOCUS Quando il bagno è anche lavanderia, l'armadiatura è adatta a contenere gli elettrodomestici e a nascondere accessori e oggetti. Dall'esterno tutto risulta ordinato.

When the bathroom is also a laundry, the cupboards are designed to hold appliances and conceal accessories and objects. A place for everything and everything in its place.

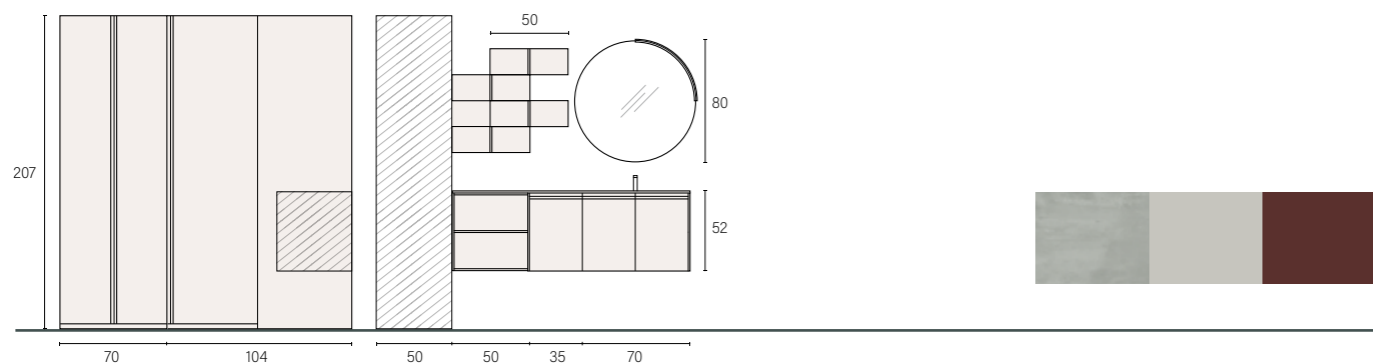

Top in Geacril® colore Grigio Efeso con vasca Lavatoio B505. Basi Thai Line laccato Grigio Efeso opaco. Elementi a Giorno laccato Rosso Jaipur opaco. Colonne Materico Malta. Specchio Sole.

Geacril® Top in Grigio Efeso colour with Washtub B505. Thai Line base units in Grigio Efeso matt lacquered. Open units in Rosso Jaipur matt lacquered. Tall units in Materico Malta. Sole mirror.

Plan en Geacril® couleur Grigio Efeso avec vasque B505. Eléments bas Thai Line laqué Grigio Efeso mat. Eléments ouverts laqué Rosso Jaipur mat. Colonne Materico Malta. Miroir Sole.

Abdeckplatte aus Geacril® Farbe Grigio Efeso mit Ausgussbecken B505. Unterschränke Thai Line Grigio Efeso matt lackert. Offene Elemente Rosso Jaipur matt lackiert. Hochschranke Materico Malta. Spiegel Sole.







Materiali / Materials
Tecnoril® - Geacril®

Lavabo con top integrato
Washbasin with integrated top

Dimensioni vasca
Washtub dimension

L 50 x P 31 H 19
Optional: tavoletta / rubbing board



Tecnoril®
Bianco opaco
Matt white



Geacril®
Bianco lucido
Glossy white

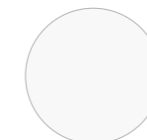

Geacril®
Bianco opaco
Matt white

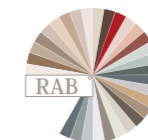

Geacril®
Colorato opaco
Matt colored

Colori a pag. 111
esclusi i metallizzati
Colours at page 111
metallized finishes not included

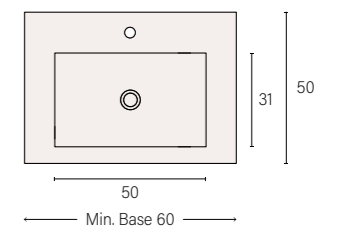
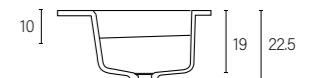

Il lavatoio dispone come optional, di una tavoletta utile a lavare i panni e utilizzabile come fondo della vasca per ridurre la profondità.

As an optional, the washtub has a rubbing board that can also be used on the bottom of the washtub sink to reduce its depth.

L'évier dispose en option d'une tablette utile pour laver le linge et utilisable comme fond de vasque pour en réduire la profondeur.

Als Sonderausstattung verfügt das Ausgussbecken über ein Waschbrett, das zum Wäschewaschen oder als Boden für das Becken verwendet werden kann, um seine Tiefe zu verringern.



SPECCHIO SOLE
SOLE MIRROR

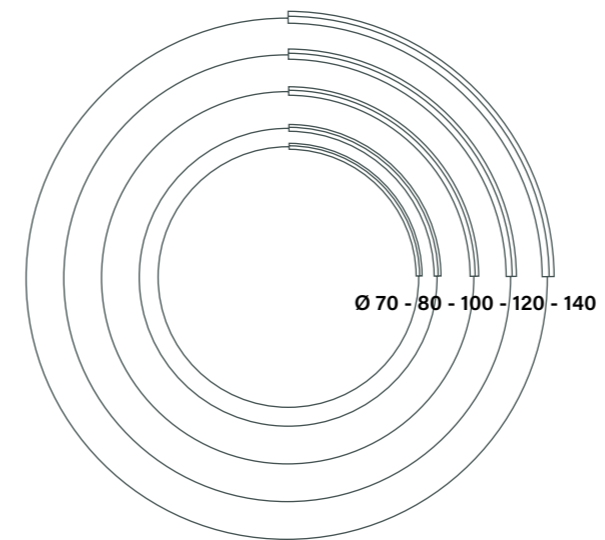

Anche lo specchio vuole la sua parte, semplice e versatile Sole è disponibile anche con luce a led posizionabile a piacere attorno al perimetro.

The mirror is also an important item. Simple and versatile, Sole is available with LED lighting to place around the edges in any way you wish.

Le miroir est également important, simple et polyvalent, Sole est également disponible avec une lumière à led que l'on peut positionner librement autour du périmètre.

Auch der Spiegel trägt seinen Teil dazu bei, der schlichte und vielseitige Spiegel Sole ist auch mit LED-Beleuchtung erhältlich, die beliebig am Rand angebracht werden kann.



FOCUS La lavanderia c'è ma non si vede. Le ante a libro si aprono in un solo gesto e consentono il facile accesso al contenuto ben organizzato all'interno dei vani. L'armadio accoglie, non solo gli elettrodomestici e gli accessori ma anche la base sospesa con lavabo e lo specchio.

The laundry's there, but out of sight. The folding doors open with a single movement and facilitate access to the well-organised interior. The cupboard holds not only appliances and accessories, but also a suspended base unit with washbasin and mirror.

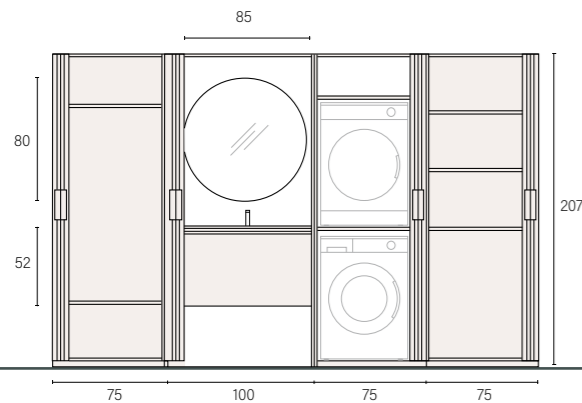

Top in Mineralux colore Cipria con Vasca Lavatoio Astra. Base Thai Line e colonne Thai Maniglia laccato Cipria opaco. Specchio Sole.

Mineralux Top in Cipria colour with Astra Washtub. Thai Line base unit and Thai Handle tall units in Cipria matt lacquered. Sole mirror.

Plan en Mineralux couleur Cipria avec Vasque Astra. Élément bas Thai Line et colonnes Thai Poignée laqué Cipria mat. Miroir Sole.

Waschtischplatte aus Mineralux Farbe Cipria mit Ausgussbecken Astra. Unterschrank Thai Line und Hochschränke Thai Griff Cipria matt lackiert. Spiegel Sole.







L'armadio è un'efficace soluzione salvaspazio che impiega l'altezza della parete per tenere tutto in ordine

The cupboard is an effective space-saving solution that occupies the height of the wall to keep everything neat and tidy.

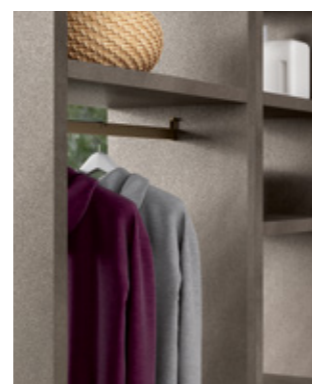

Cesto portabiancheria estraibile, appendiabiti e portascarpe sono le attrezzature indispensabili per rendere l'armadio iperfunzionale.

Pull-out laundry basket, clothes hanger and shoe cupboard are all essential to make the cupboard extra-practical.

Panier à linge extractible, tringle et porte-chaussures sont les équipements pour rendre l'armoire hyperfonctionnelle.

Ausziehbarer Wäschekorb, Kleiderstange und Schuhablage sind unerlässlich, um dem Schrank besondere Funktionalität zu verleihen.

FOCUS L'anta a libro per il vano da L 75 cm è la soluzione ideale per agevolare l'accesso a lavatrice e asciugatrice: si ripiega in poco spazio in un solo movimento.

The folding door on the L 75cm compartment is the ideal solution to facilitate access to the washing machine and dryer: it takes up very little space and folds away with a single movement.

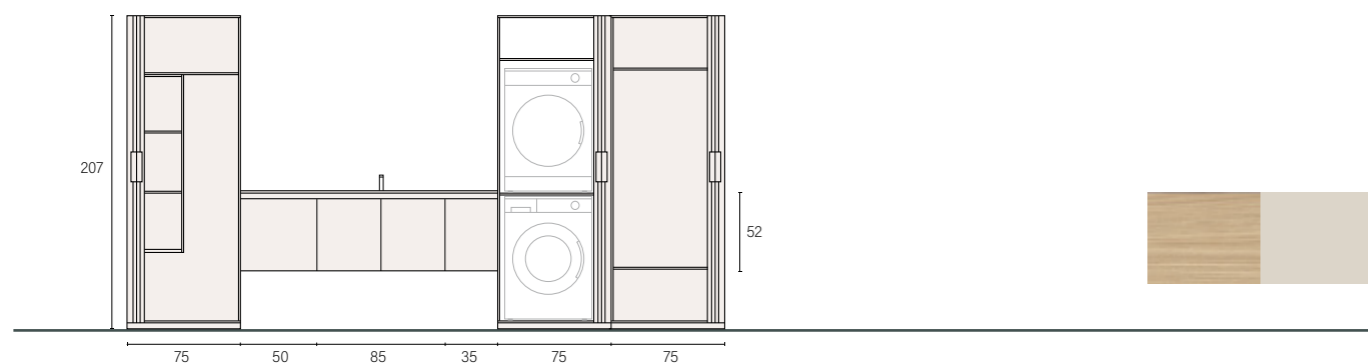

Top in Mineralux colore Seta con Vasca Lavatoio Gaia. Basi Thai Gola Materico Rovere Chiaro. Colonne Thai Maniglia laccato Seta opaco.

Mineralux Top in Seta colour with Gaia Washbasin. Thai Grip Profile base units in Materico Rovere Chiaro. Thai Handle tall units in Seta matt lacquered.

Plan en Mineralux couleur Seta avec Vasque Gaia. Éléments bas Thai Gorge Materico Rovere Chiaro. Colonnes Thai Poignée laquée Seta mat.

Waschtischplatte aus Mineralux Farbe Seta mit Ausgussbecken Gaia. Unterschränke Thai Griffprofil Materico Rovere Chiaro. Hochschränke Thai Griff Seta matt lackiert.







 **VASCA LAVATOIO WASHTUB**

GAIA

Materiali / Materials
Mineralux

Lavabo con top integrato
Washbasin with integrated top

Dimensioni vasca
Basin dimension

L 62 x P 45 H 31
Optional: tavoletta / rubbing board

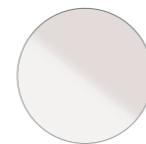

Mineralux
Bianco lucido
Glossy white



Mineralux
Bianco opaco
Matt white

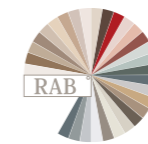

Mineralux
Colorato opaco
Matt colored

Colori a pag. 111
esclusi i metallizzati
Colours at page 111
metallized colours not included

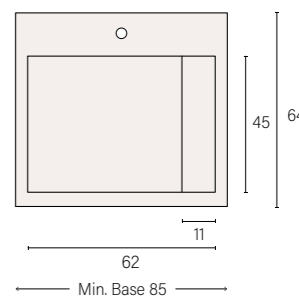
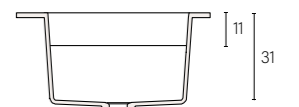

La caratteristica del lavatoio Gaia è la sagomatura interna che forma su un lato un comodo piano d'appoggio per spugne e saponi.

The Gaia washtub features special internal shaping that creates a convenient shelf on one side for sponges and soap.

La caractéristique de l'évier Gaia est le façonnage qui forme sur un côté un plan d'appui pratique pour les éponges et les savons.

Das besondere Merkmal des Ausgussbeckens Gaia ist seine innere Formgebung, die auf einer Seite eine bequeme Ablage für Schwämme und Seifen bietet.

FOCUS Il mobile lavanderia è versatile perchè si adatta anche agli ambienti più stretti. Si configura adattandosi allo spazio a disposizione grazie ai moduli inclinati e a profondità ridotta.

Our laundry cabinets are versatile because they will fit into even the narrowest space. Inclined modules with reduced depth can be configured to adapt to the space available.

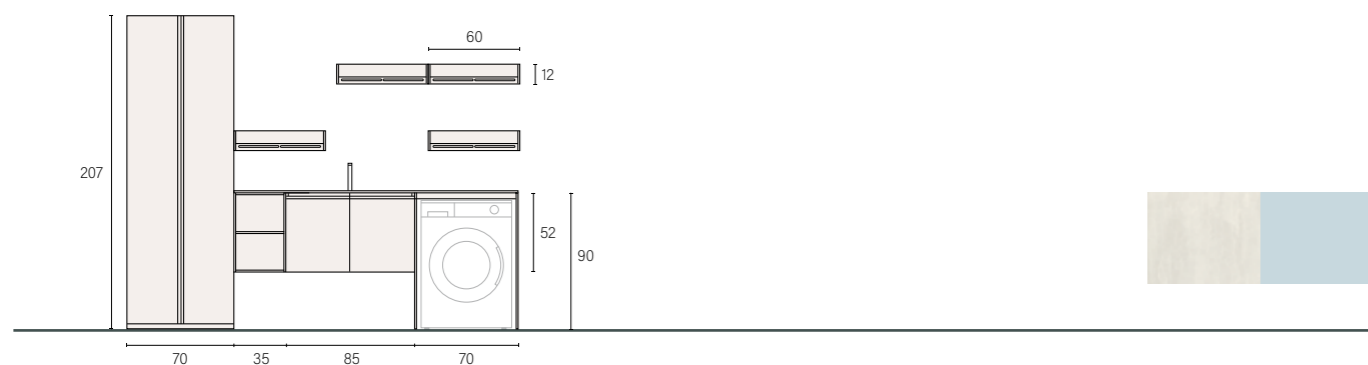

Top in Mineralux colore Acquamarina con Vasca Lavatoio Gaia. Basi e colonna Thai Line Materico Talco.

Mineralux Top in Acquamarina colour with Gaia Washbasin. Thai Line base and tall units in Materico Talco.

Plan en Mineralux couleur Acquamarina avec Vasque Gaia. Éléments bas et colonnes Thai Line Materico Talco.

Waschtischplatte aus Mineralux Farbe Acquamarina mit Ausgussbecken Gaia. Unterschränke und Hochschrank Thai Line Materico Talco.







 GAIA | VASCA LAVATOIO WASHTUB

FOCUS La colonna a giorno accoglie lavatrice e asciugatrice in poco spazio, può essere allestita anche con ripiani e accessori a seconda delle esigenze.

The open tall unit accommodates a washing machine and dryer in a small space and can be provided with shelves and accessories to requirements.

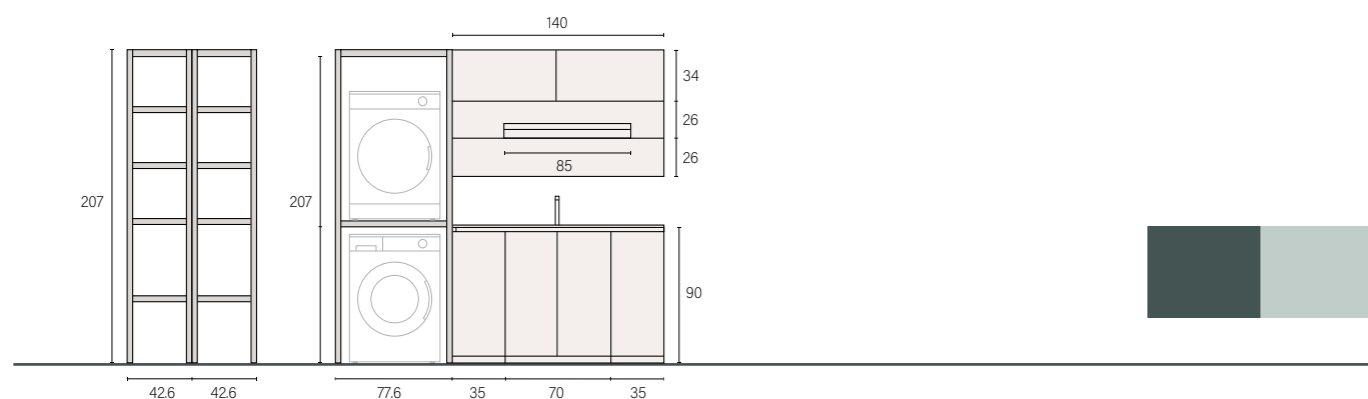

Top in Geacril® colore Verde Comodoro con Vasca Lavatoio B608. Pensili e Basi Thai Gola con ante laccato Nebbia opaco. Colonne a Giorno laccato Verde Comodoro opaco.

Geacril® Top in Verde Comodoro colour with Washtub B608. Thai Grip Profile wall and base units with Nebbia matt lacquered doors. Open tall units in Verde Comodoro matt lacquered.

Plan en Geacril® couleur Verde Comodoro avec Vasque B608. Éléments Hauts et Bas Thai Gorge avec portes en laqué Nebbia mat. Colonne ouvertes laqué Verde Comodoro mat.

Waschtischplatte aus Geacril® Farbe Verde Comodoro mit ausgussbecken B608. Hängeschränke und Unterschränke Thai Griffprofil mit Türen Nebbia matt lackiert. offene Hochschränke Verde Comodoro matt lackiert.







Materiali / Materials
Tecnoril® - Geacril®

Lavabo con top integrato
Washbasin with integrated top

Dimensioni vasca
Basin dimension

L 50 x P 31 H 20

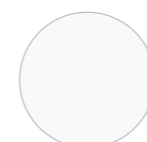

Tecnoril®
Bianco opaco
Matt white

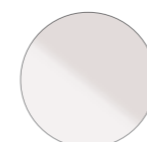

Geacril®
Bianco lucido
Glossy white

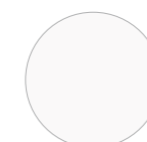

Geacril®
Bianco opaco
Matt white



Geacril®
Colorato opaco
Matt colored

Colori a pag. 111
esclusi i metallizzati
Colours at page 111
metallized colours not included

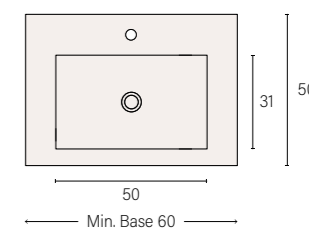

Il colore è un valore aggiunto per il Geacril® materiale dall'aspetto vellutato con il quale si può realizzare il top con lavatoio integrato.

Colour is an added value of Geacril®, a velvet-touch material used for tops with integrated washtub.

La couleur est une valeur ajoutée pour le Geacril®, matériau à l'aspect velouté avec lequel il est possible de réaliser le top avec évier intégré.

Die Farbe ist ein Mehrwert für Geacril®, ein Material mit samtigem Aussehen, aus dem die Waschtischplatte mit integriertem Waschbecken hergestellt werden kann.

FOCUS Un monoblocco attrezzato con basi contenitive, con il lavatoio e le mensole portaoggetti. La struttura è dotata di luce a led per illuminare la zona lavoro.

An equipped suite with base storage units, washtub and shelves. The structure is provided with led lighting to illuminate the work area.

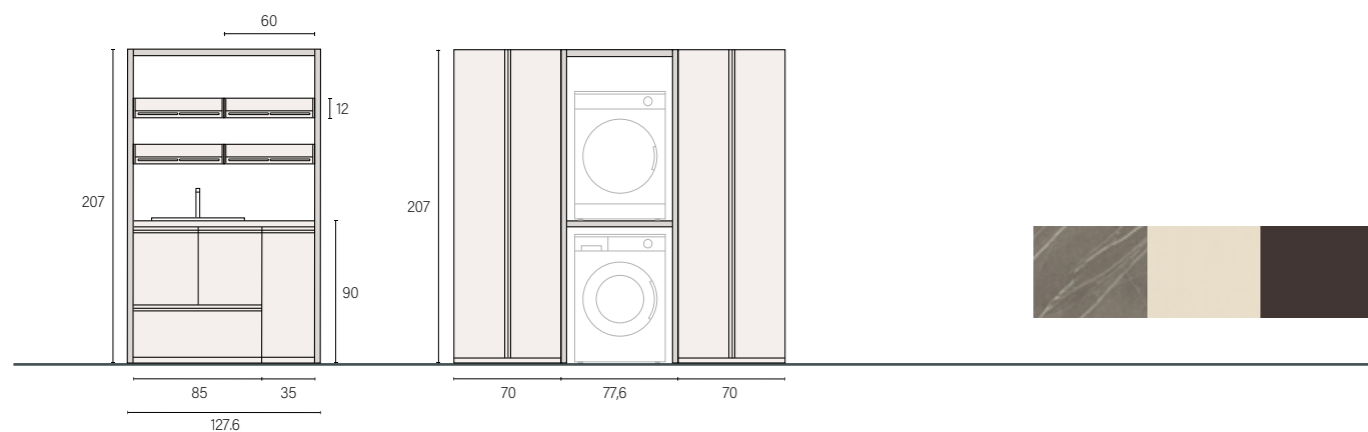

Struttura a giorno in HPL Selce. Lavatoio in ceramica Time. Basi Thai Line Materico Vaniglia. Mensole laccato Cacao Orinoco opaco. Colonne Thai Line Materico Vaniglia. Struttura a Giorno laccato Cacao Orinoco opaco.

HPL open structure in Selce colour. Time ceramic Washtub. Thai Line base units in Materico Vaniglia. Shelves in Cacao Orinoco matt lacquered. Thai Line tall units in Materico Vaniglia. Open structure in Cacao Orinoco matt lacquered.

Structure ouverte en HPL Selce. Evier en céramique Time. Eléments bas Thai Line Materico Vaniglia. Etagères en laqué Cacao Orinoco mat. Colonnes Thai Line en Materico Vaniglia. Structure ouverte laqué Cacao Orinoco mat.

Offene Struktur aus HPL Selce. Ausgussbecken aus Keramik Time. Unterschränke Thai Line aus Materico Vaniglia. Borde aus Cacao Orinoco matt lackiert. Hochschränke Thai Line aus Materico Vaniglia. Offene Struktur aus Cacao Orinoco matt lackiert.







FOCUS Le colonne sono disponibili in profondità differenti per adattarsi alla dimensione di lavatrice e asciugatrice.

Tall units are available with different depths to adapt to the dimensions of washing machine and dryer.

FOCUS Le strutture a giorno autoportanti e bifacciali sono adatte a delimitare e a suddividere lo spazio lavanderia senza bisogno di pareti aggiuntive. L'accesso a ripiani e accessori avviene da entrambi i lati.

The load-bearing, double-faced open units can be used to border and sub-divide laundry space without the need for additional walls. Shelves and accessories can be accessed from both sides.

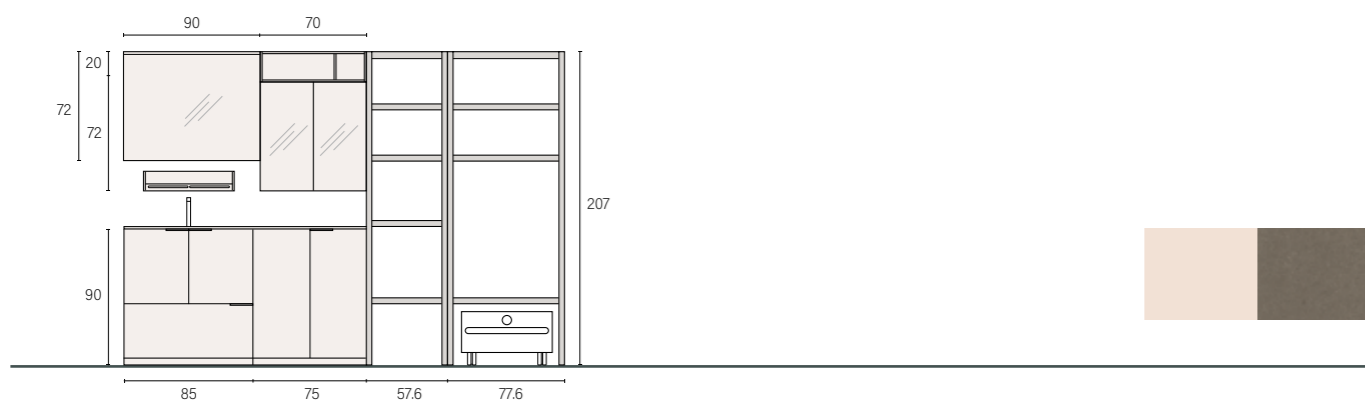

Top in Geacril® colore Nude con Vasca Lavatoio B505. Basi Thai Maniglia laccato Nude opaco. Colonne a Giorno Materico Roccia.

Geacril® top in Nude colour with washtub B505. Thai Handle base units in Nude matt lacquered. Open tall units in Materico Roccia.

Plan en Geacril® couleur Nude avec Vasque Evier B505. Éléments bas Thai Poignée laqué Nude mat. Colonnes ouvertes en Materico Roccia.

Waschtischplatte aus Geacril® Farbe Nude mit Ausgussbecken B505. Unterschränke Thai Griff aus Nude matt lackiert. Offene Hochschränke aus Materico Roccia.







 **B505** | VASCA LAVATOIO WASHBASIN



Nelle strutture a giorno tutto è a vista ma ben ordinato

Open units keep everything neatly in sight

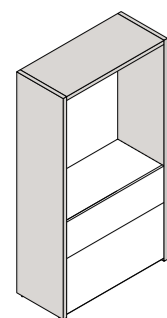

Colonna cornice
Frame tall unit

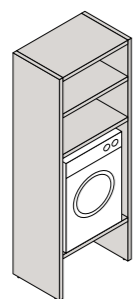

Colonna per lavatrice rialzata
Tall unit for raised washing machine

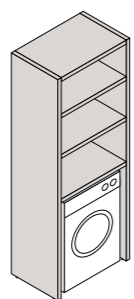

Colonna per lavatrice con ripiani
Tall unit for washing machine with shelves

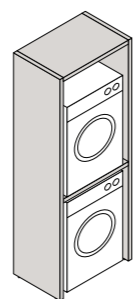

Colonna per due elettrodomestici
Tall unit for two electric appliances.

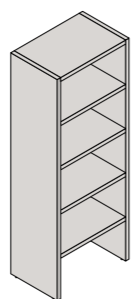

Colonna con ripiani
Tall unit with shelves

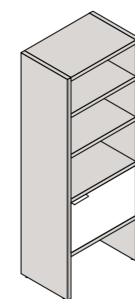

Colonna con ripiani e contenitore
Tall unit with shelves and storage unit

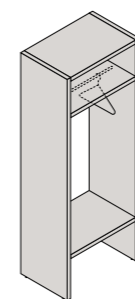

Colonna per 1 appendiabiti
Tall unit for 1 clothes hanging rail

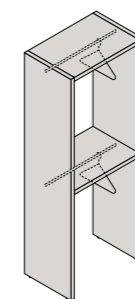

Colonna per 2 appendiabiti
Tall unit for 2 clothes hanging rails

STRUTTURA A GIORNO ALTA

OPEN HIGH STRUCTURE

Le diverse conformazioni delle strutture a giorno sono studiate per ogni tipo di esigenza: contenere uno o più elettrodomestici, accogliere attrezzature e accessori, organizzare lo spazio in altezza con i ripiani, nascondere con ante che chiudono i vani.

The different conformations of open units are designed to meet all needs: to hold one or more appliances, house equipment and accessories, organise vertical space with shelves, or conceal everything behind doors.

Les différentes conformations des structures ouvertes sont étudiées pour tout type d'exigence : contenir un ou plusieurs électroménagers, ranger des équipements et des accessoires, organiser l'espace en hauteur avec des étagères, cacher avec des portes qui ferment les compartiments.

Die verschiedenen Gestaltungsmöglichkeiten der offenen Strukturen sind für jede Anforderung konzipiert: zur Aufnahme von einem oder mehreren Elektrogeräten, zur Unterbringung von Ausrüstungen und Zubehör, zur Organisation des Raumes in der Höhe mit Fachböden, zum Verbergen mit Türen, um die Fächer zu verschließen.



FOCUS L'ampio specchio accresce il senso di profondità nella stanza e cela un capiente pensile contenitore alto 117 cm allestito con ripiani in vetro temperato.

The large mirror enhances the room with a sense of depth and conceals an ample H 117 cm wall unit with toughened glass shelves.



Top in HPL Brunito con Lavatoio in ceramica Time. Basi, Contenitore a Specchio e Colonne Thai Maniglia laccato Zenzero opaco. Colonne a giorno Materico Cannella.

Burnished HPL Top with Time ceramic Washtub. Thai Handle base units, Mirror storage unit and tall units in Zenzero matt lacquered. Open tall units in Materico Cannella.

Plan en HPL Bruni avec Evier en céramique Time. Eléments bas, Elément de rangement à Miroir et Colonne Thai Poignée laqué Zenzero mat. Colonne ouverte en Materico Cannella.

Waschtischplatte aus HPL Brüniert mit Ausgussbecken aus Keramik Time. Unterschränke, Schrankelement Spiegel und Hochschränke Thai Griff aus Zenzero matt lackiert. Offene Hochschränke aus Materico Cannella.







Materiali / Materials
Ceramica / Ceramic

Lavatoio Time
Time washbasin

Dimensioni vasca
Basin dimension

61 x P 51,5 H 23,5
Optional: tavoletta / rubbing board

Lavatoio Time disponibile in versione Consolle (01) o in versione sopra piano (02). Time washtub available in Console version (01) or overtop version (02).

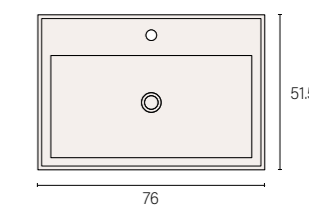
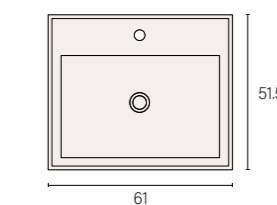
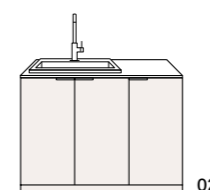
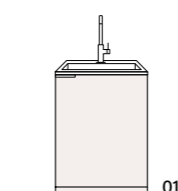

La ceramica bianca valorizza il lavatoio che acquista un aspetto lucente e risulta perfettamente liscio al tatto. Materiale resistente agli urti e ai graffi.

White ceramics make this washtub attractive, with its glow and perfectly smooth surface, which is shock and scratch resistant.

La céramique blanche valorise l'évier qui acquiert un aspect brillant et s'avère parfaitement lisse au toucher. Matériau résistant aux chocs et aux rayures.

Die weiße Keramik wertet das Ausgussbecken auf, das ein glänzendes Aussehen erhält und sich vollkommen glatt anfühlt. Stoß- und kratzfestes Material.

La base con ante ospita al suo interno tutto il necessario per la lavanderia

The base unit with door accommodates everything a laundry must have



La base a terra si sviluppa in orizzontale ed è predisposta per racchiudere al suo interno gli elettrodomestici e tutti gli accessori, come il portascarpe e il cesto porta biancheria estraibile.

A floor-standing base unit develops horizontally and is designed to house appliances and accessories such as a shoe cupboard and pull-out laundry basket.

L'élément bas au sol se développe à l'horizontale et est prévu pour contenir les électroménagers et tous les accessoires, comme le porte-chaussures et le panier à linge extractible.

Der stehende Unterschrank verläuft horizontal und ist so konzipiert, dass er Elektrogeräte und sämtliches Zubehör, wie z. B. die Schuhablage und den ausziehbaren Wäschekorb, aufnehmen kann.

FOCUS Il progetto modulare della parete lavanderia affianca strutture a giorno di larghezze e altezze diverse ad armadiature, vani chiusi e cestoni.

A modular project for the laundry wall combines open units of different widths and heights with cupboards, closed compartments and deep drawers.

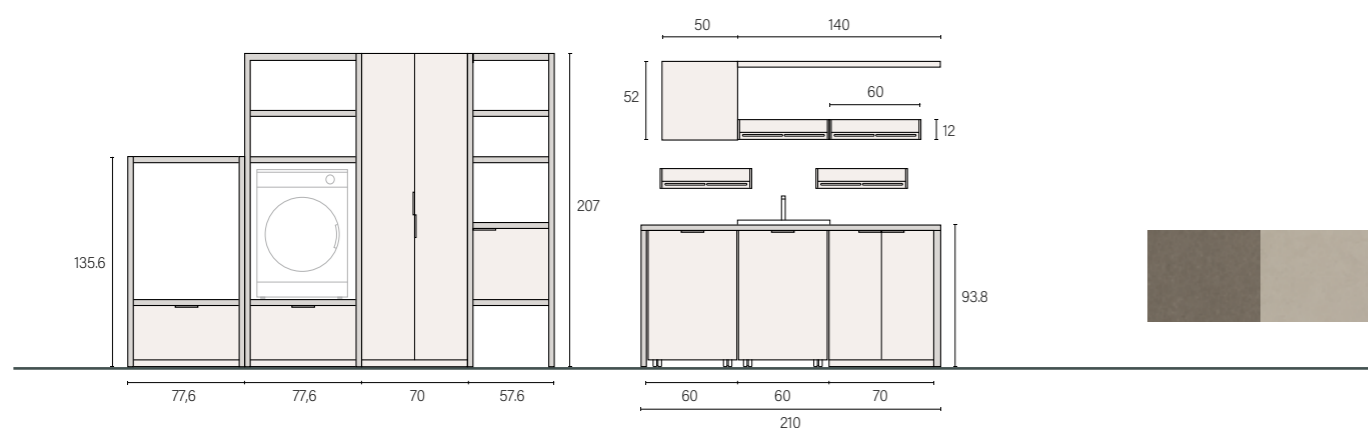

Strutture a Giorno Materico Roccia. Lavatoio in ceramica Time. Frontali Thai Maniglia Materico Deserto.

Open structures in Materico Roccia. Time ceramic Washtub. Thai Handle fronts in Materico Deserto.

Structures ouvertes en Materico Roccia. Evier en céramique Time. Façades Thai Poignée en Materico Deserto.

Offene Strukturen aus Materico Roccia. Ausgussbecken aus Keramik Time. Fronten Thai Griff aus Materico deserto.





BASE A GIORNO
OPEN BASE UNIT



FOCUS La base a giorno nasce per fare da cornice agli elettrodomestici e fornire un comodo piano d'appoggio nel quale incassare anche il lavabo. Lo spazio sottostante può essere dotato di carrelli su ruote.

This open base unit frames appliances and provides a convenient worktop, which hosts a recessed sink. The space underneath can be provided with trolleys on castors.





FOCUS Tutto è studiato per essere piacevole alla vista e adeguato per l'utilizzo. Dal capiente lavatoio alle colonne attrezzate.

Everything is designed to be attractive and suitable for its intended use, including a capacious washtub and tall storage units.





Top in Mineralux colore Nude con Vasca Lavatoio Astra. Basi Thai Gola laccato Pesca opaco. Mensole in metallo laccato Nude opaco. Specchio modello Sector. Strutture a Giorno Materico Malta.

Mineralux Top in Nude colour with Astra Washtub. Thai Grip Profile base units in Pesca matt lacquered. Metal shelves in Nude matt lacquered. Sector Mirror. Open structures in Materico Malta.

Plan en Mineralux couleur Nude avec Vasque Evier Astra. Éléments bas Thai Gorge en laqué Pesca mat. Etagères en métal laqué nude mat. Miroir Sector. Structures ouvertes en Materico Malta.

Waschtischplatte aus Mineralux Farbe Nude avec Ausgussbecken Astra. Unterschranke Thai Griffprofil Pesca matt lackiert. Borde aus Metall Nude matt lackiert. Spiegel Sector. Offene Strukturen aus Materico Malta.







Materiali / Materials
Mineralux

Lavabo con top integrato
Washbasin with integrated top

Dimensioni vasca
Basin dimension

L 52 x P 33 H 26
Optional: tavoletta / rubbing board

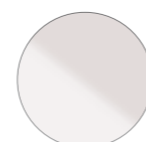

Mineralux
Bianco lucido
Glossy white

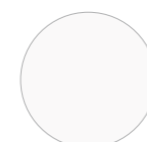

Mineralux
Bianco opaco
Matt white



Mineralux
Colorato opaco
Matt colored

Colori a pag. 111
esclusi i metallizzati
Colours at page 111
metallized colours not included

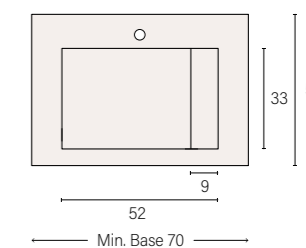

Mineralux è un materiale liscio e satinato, piacevole al tatto ed estremamente resistente.

Mineralux is a smooth and satin material, pleasant to the touch and extremely resistant.

Mineralux est une matière lisse et satinée, agréable au toucher et extrêmement résistant.

Mineralux ist ein glattes und satiniertes, berührungsfreundliches und extrem widerstandsfähiges Material.



COLONNE A GIORNO DOPPIE
DOUBLE OPEN TALL UNITS



Per renderne confortevole l'utilizzo, gli elettrodomestici sono posizionati sul ripiano rialzato. Lo spazio utile sotto può essere attrezzato con cestone e ripiano estraibile o con cesto su ruote.

For greater comfort in use, appliances are placed on a raised shelf. The space below can be provided with deep drawers and pull-out shelves or laundry baskets on castors.

Pour faciliter l'utilisation, les électroménagers sont positionnés sur l'étagère surélevée. L'espace utile en dessous peut être équipé avec un caisson et une étagère extractible ou avec un caisson sur roulettes.

Für eine bequeme Nutzung werden die Elektrogeräte auf dem erhöhten Fachboden platziert. Die Nutzfläche darunter kann mit einem Auszug und einem ausziehbaren Fachboden oder mit einem Auszug auf Rollen eingerichtet werden.



Come disporre lavatrice e asciugatrice

How to position washing machine and dryer

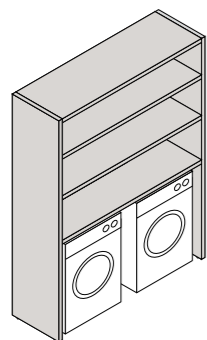

Colonna doppia
Double tall unit

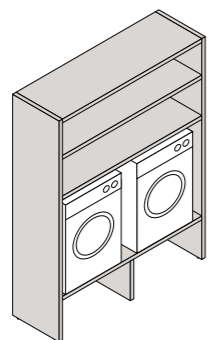

Colonna doppia
Double tall unit

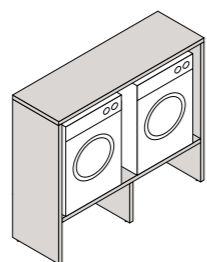

Semicolonna doppia
Double semi-tall unit

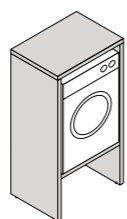

Semicolonna singola
Single semi-tall unit

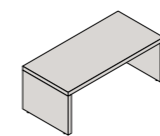

Panca
Bench

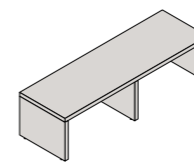

Panca doppia
Double bench



COLONNA A GIORNO DOPPIA E PANCA

DOUBLE OPEN TALL UNIT AND BENCH

La struttura a giorno è disponibile anche in doppia larghezza e ad altezza ridotta. In alternativa lavatrice e asciugatrice possono essere sollevate da terra attraverso le panche.

The open unit is also available with double width and reduced height. As an alternative, washing machine and dryer can be placed above ground on benches.

La structure ouverte est également disponible avec une double largeur et une hauteur réduite. Sinon, il est possible de soulever le lave-linge et le sèche-linge à l'aide de bancs.

Die offene Struktur ist auch in doppelter Breite und reduzierter Höhe erhältlich. Alternativ können Waschmaschine und Wäschetrockner über die Bankelemente vom Boden angehoben werden.

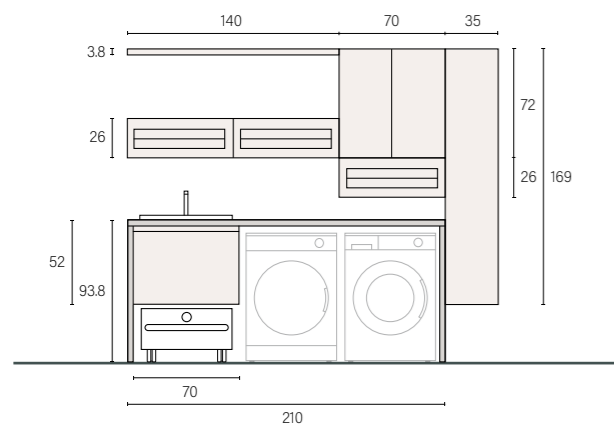

FOCUS La base a giorno è l'elemento d'unione tra le varie parti che compongono la lavanderia.

The open base unit is the element uniting the different parts that make up the laundry

Strutture a Giorno Materico Rovere Chiaro con Lavatoio Idra in Geacril® colore Piombo. Base e Pensili Thai Gola laccato Piombo opaco. Pannelli Materico Rovere Chiaro e Mensole in metallo laccato Piombo opaco con retro illuminazione a led.

Open structures in materico Rovere Chiaro with Idra Washtub Geacril® in piombo colour. Thai Grip Profile base and wall unit in Piombo matt lacquered. Panels in Materico Rovere Chiaro and Metal shelves in Piombo matt lacquered with Led backlit.

Structures ouvertes en Materico Rovere Chiaro avec Evier Idra en Geacril® couleur Piombo. Élément Bas et Haut Thai Gorge laqué Piombo mat. Panneaux en Materico Rovere Chiaro et Etagères en métal laqué Piombo mat avec éclairage led sur l'arrière.

Offener Struktur aus Materico Rovere Chiaro mit Ausgussbecken Idra aus Geacril® Farbe Piombo. Unterschrank und Hängeschränke Thai Griffprofil in Piombo matt lackiert. Platten aus Materico Rovere Chiaro und Borde aus Metall in Piombo matt lackiert mit LED-Hintergrundbeleuchtung.



52



Materiali / Materials
Tecnoril® - Geacril®

Lavabo versione sopra piano
Washbasin version top for base units

Dimensioni vasca
Basin dimension L 50 x P 40 H 19



Tecnoril®
Bianco opaco
Matt white

Geacril®
Bianco lucido
Glossy white

Geacril®
Bianco opaco
Matt white

Geacril®
Colorato opaco
Matt colored

Colori a pag. 111
esclusi i metallizzati
Colours at page 111
metallized colours not included

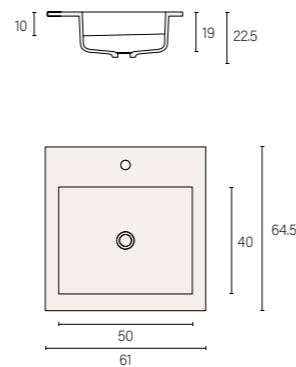

Il lavatoio Idra, disponibile in versione consolle o sopra piano, quando diventa vasca lavatoio integrata nel top è nominata B506.

The Idra Washtub available in console or above top version, when integrated in the top is B506

L'évier Idra, disponible en version consolle ou sur plan, quand est intégré dans le plan est nommé B506.

Der Ausgussbecken, erhältlich in der Variant Konsole oder über der Platte wenn in der Washplatte integriert wird, ist B506 nominiert.

IDRA LAVATOIO / WASHTUB

Versione Consolle per base L 60 P 64
Console version for base unit W 60 P 64



L 61

Versione Soprapiano per basi P 64/70
Top version for base units D 64/70



L 61

B506 VASCA LAVATOIO / WASHTUB

Vasca Lavatoio integrata su top sopra piano per basi P 64/70, vasca lato destro o sinistro.
Washtub integrated in the base unit above top P 64/70, washtub position right or left side.



Top max L 180

Vasca Lavatoio integrata sul top per basi P 64/70.
Washtub integrated in the base unit top P 64/70.



Top max L 300

FOCUS La lavanderia è concepita come un luogo funzionale e ben organizzato, è realizzata con materiali d'effetto ma soprattutto resistenti e facili da pulire.

The laundry is conceived as a practical, well organised place and features robust, attractive materials that are easy to clean.

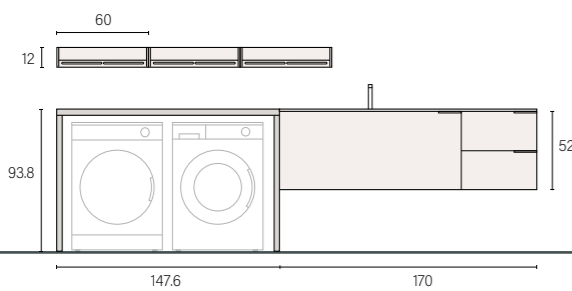

Top in Mineralux Bianco opaco con Vasca Lavatoio Gaia. Struttura a Giorno in HPL Spaccato. Basi Thai Maniglia laccato Bianco opaco. Mensole laccate Ardesia opaco.

Mineralux top in Mat Bianco with Gaia Washtub. HPL Open Structure. Thai Handle base units in Bianco matt lacquered. Shelves in Ardesia matt lacquered.

Plan en Mineralux Bianco mat avec Vasque Evier Gaia. Structure ouverte en HPL. Eléments bas Thai Poignée laqué Bianco mat. Etagères en laqué Ardesia mat.

Waschtischplatte aus Mineralux Bianco mit Ausgussbecken Gaia. Offene Struktur aus HPL. Unterschränke Thai Griff in Bianco matt lackiert. Borde aus Ardesia matt lackiert.







FOCUS La base a giorno nella sua semplicità promette grandi vantaggi: un ampio piano d'appoggio, un alloggio per il lavabo, un sostegno per le basi sospese, una sede per i carrelli su ruote.

Although simple, the open base unit has many advantages: a large worktop, sink housing, support for suspended base units and a place to accommodate trolleys on castors.

Base a giorno L 210 allestita con base sospesa, cesto su ruote ed elettrodomestici.

Open base unit W. 210 with suspended base unit, basket on castors and electric appliances

Élément bas ouvert L.210 avec élément bas, panier sur roulettes et électroménagers.

Offener Unterschrank B 210 mit Hängeunterschrank, Korb mit Rollen und Elektrogeräte.



Base a giorno L 210 allestita con base a terra e carrelli su ruote.

Open base unit W 210 with floor-standing base unit and trolleys on castors.

Élément bas ouvert L 210 avec élément bas au sol et chariots sur roulettes.

Offener Unterschrank B 210 mit Unterschrank am Boden und Wagen mit Rollen

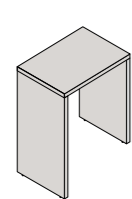

Base a giorno
singola
Single open base
unit

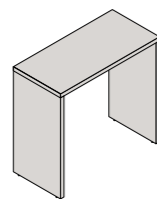

Base a giorno
doppia
Double open base
unit



FOCUS È possibile arredare una lavanderia domestica anche in poco spazio grazie alla forma ergonomica di base e lavatoio con profondità differenti.

A household laundry can be set up even where space is at a premium, thanks to the ergonomics of the base unit and washtub with different depths.

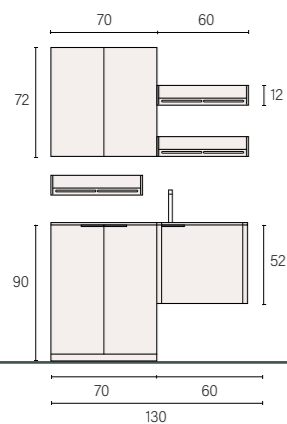

Top in Geacril® Bianco lucido con Vasca Lavatoio B372. Basi Thai Maniglia laccato Cemento opaco. Pensile laccato Grigio Efeso opaco.

Geacril® Top in Glossy White with Washtub B372. Thai Handle base units in Cemento matt lacquered. Wall unit in Grigio Efeso matt lacquered.

Plan en Geacril® en Bianco brillant avec Vasque Evier B372. Eléments bas Thai Poignée laqué Cemento mat. Elément haut laqué Grigio Efeso mat.

Waschtischplatte aus Geacril® in Glänzend Bianco mit Ausgussbecken B372. Unterschranke Thai Griff in Cemento matt lackiert. Hängeschrank in Grigio Efeso matt lackiert.





Materiali / Materials
Tecnoril® - Geacril®

Lavabo con top integrato
Washbasin with integrated top

Dimensioni vasca
Basin dimension

L 41 x P 50/25 H 22
Sinistro e Destro / Left and Right

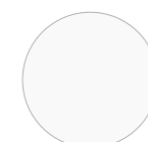

Tecnoril®
Bianco opaco
Matt white

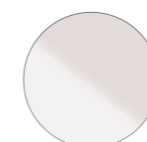

Geacril®
Bianco lucido
Glossy white

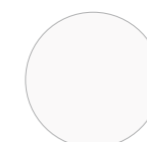

Geacril®
Bianco opaco
Matt white



Geacril®
Colorato opaco
Matt coloured

Colori a pag. 111
esclusi i metallizzati
Colours at page 111
metallized colours not included

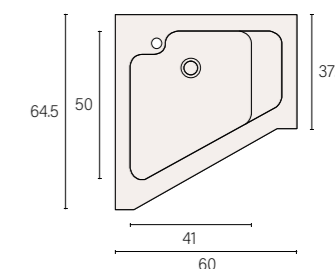

Il lavatoio risulta profondo e spazioso nonostante la forma ergonomica adatta per una base con profondità diverse.

The washtub is deep and spacious with its ergonomic shape suitable for base units with different depths.

L'évier s'avère profond et spacieux malgré la forme ergonomique adaptée à une base avec différentes profondeurs.

Das Ausgussbecken ist tief und geräumig, trotz seiner ergonomischen Form, die sich für einen Unterschrank mit verschiedenen Tiefen eignet.

FOCUS Le pratiche mensole sono disegnate appositamente per contenere in sicurezza oggetti e barattoli. Il metallo è il materiale principale perchè resistente e facile da pulire.

The practical shelves are specially designed to safely hold objects and jars. Because they feature metal as their main material, they are robust and easy to clean.

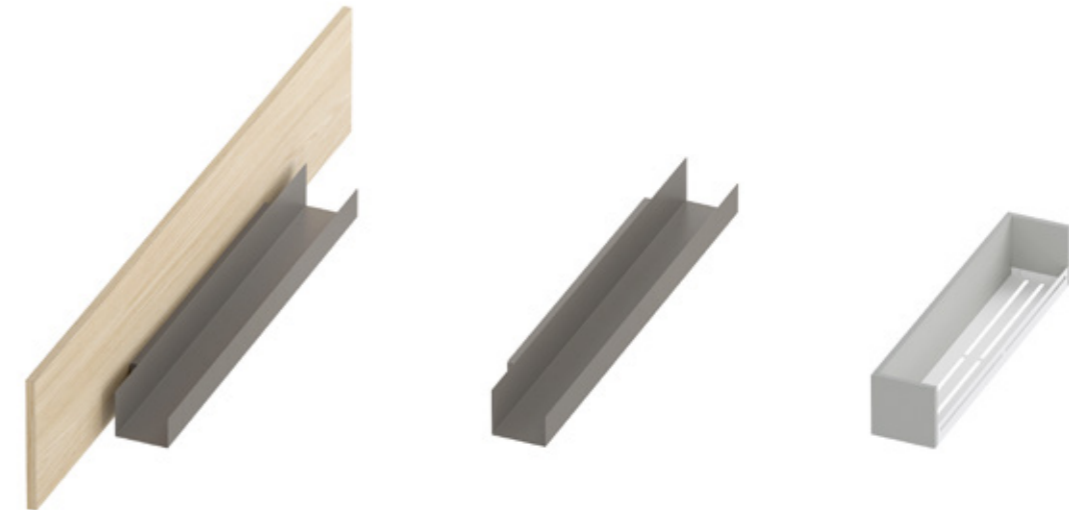

1. Pannello boiserie larghezza su misura
Panel for shelf custom width
H 26/34/52 P 1,8

2. Mensola / shelf
L 60/85 H 9 P 13

3. Mensola / shelf
L 60 H 12 P 12

1. Pannello per mensola disponibile in tutte le finiture.
Panel for shelf available in all finishes.
Panneau pour étagère disponible en toutes les finitions.
Platte für bord in allen Ausführungen erhältlich.

2. Mensola in metallo laccato opaco.
Matt lacquered metal shelf.
Étagère en métal laqué mat.
Bord aus matt lackiertem Metall.

3. Mensola in legno laccato opaco con griglia in metallo bianco opaco.
Matt lacquered wooden shelf with matt white metal rack.
Étagère en bois laqué mat avec grille en métal blanc mat.
Bord aus Matt lackiertem Holz mit mattweißes Metallgitter.

4. Mensola in legno con Led disponibile in tutte le finiture.
Wooden shelf with led available in all finishes.
Étagère en bois avec led disponible dans toutes les finitions.
Bord aus Holz mit Led in allen Ausführungen erhältlich.



4. Mensola con Led larghezza su misura
Shelf with led custom width
P 20/37 Sp. 3,8



CESTO SU RUOTE
BASKET ON CASTORS

Cesto su ruote disponibile bianco opaco.

Basket on castors available in matt white.

Panier sur roulettes disponible blanc mat.

Korb mit Rollen in Weiss Matt erhältlich.



CARRELLO SU RUOTE
TROLLEY ON CASTORS

Carrello su ruote per base a giorno disponibile bianco opaco con frontale nelle finiture Materico o laccato nei colori lucidi e opachi.

Trolley on castors in matt Bianco with Front available in Materico or lacquered finishes in glossy or matt colours.

Chariot sur roulettes pour élément bas ouvert disponible bianco mat avec façade dans les finitions Materico ou laqué dans les couleurs brillantes et mates.

Wagen mit Rollen für offenen Unterschrank In Bianco Matt erhältlich mit Front in den Ausführungen Materico oder lackiert in glänzenden und matten Farben.



APPENDIABITI
CLOTHES HANGING RAIL

Tube appendiabiti in metallo brunito per vani da L 50/60/70/75.

Clothes hanging rail in burnished metal for W 50/60/70/75 compartments.

Tringle en métal bruni pour compartiments de L 50/60/70/75.

Kleiderstange aus brüniertes Metall für Fächer B 50/60/70/75.



CESTO PORTABIANCHERIA ESTRAIBILE
PULL-OUT LAUNDRY BASKET

Cesto portabiancheria estraibile in metallo antracite per vani da L 35/50/70.

Pull-out laundry basket in anthracite Metal For W 35/50/70 compartments.

Panier à linge extractible en métal anthracite pour compartiments de L 35/50/70.

Ausziehwäschekorb aus Metall Anthrazit für Fächer B 35/50/70.



PORTASCARPE
SHOE RACK

Portascarpe estensibile in metallo per vani da L 50/60/70/75.

Shoe rack hanging rail in metal W 50/60/70/75.

Porte-chaussures extensible en métal pour compartiments de L 50/60/70/75.

Ausziehschuhregal aus Metall für Fächer B 50/60/70/75.



ILLUMINAZIONE A LED
STRUCTURE WITH LED

Strip led per fianco o ripiano. Luce naturale 4000° k.

Led strip for side or shelf. Natural light 4000° k.

Strip led pour côté ou étagère. Lumière naturelles 4000° k.

LED-Streifen für Seitenwand und Fachboden. Natürliches Licht 4000° K.

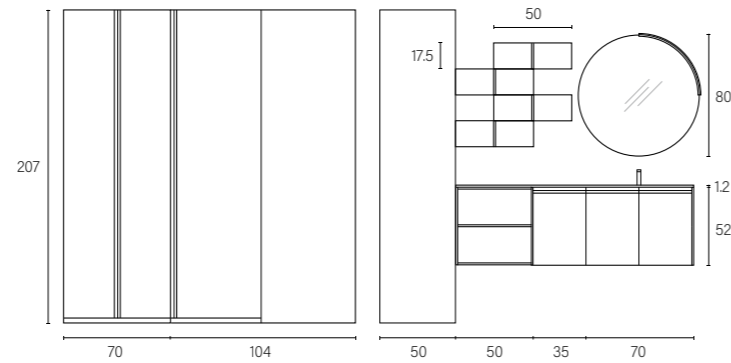

Top in Geacril® colore Grigio Efeso con vasca Lavatoio B505. Basi Thai Line laccato Grigio Efeso opaco. Elementi a Giorno laccato Rosso Jaipur opaco. Colonne Materico Malta. Specchio Sole.

Geacril® Top in Grigio Efeso colour with Washtub B505. Thai Line base units in Grigio Efeso matt lacquered. Open units in Rosso Jaipur matt lacquered. Tall units in Materico Malta. Sole mirror.

Plan en Geacril® couleur Grigio Efeso avec vasque B505. Eléments bas Thai Line laqué Grigio Efeso mat. Eléments ouverts laqué Rosso Jaipur mat. Colennes Materico Malta. Miroir Sole.

Abdeckplatte aus Geacril® Farbe Grigio Efeso mit Ausgussbecken B505. Unterschränke Thai Line Grigio Efeso matt lackert. Offene Elemente Rosso Jaipur matt lackiert. Hochschranke Materico Malta. Spiegel Sole.

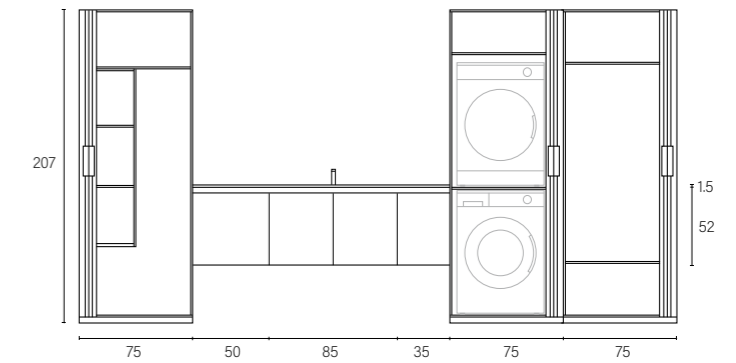

Top in Mineralux colore Seta con Vasca Lavatoio Gaia. Basi Thai Gola Materico Rovere Chiaro. Colonne Thai Maniglia laccato Seta opaco.

Mineralux Top in Seta colour with Gaia Washbasin. Thai Grip Profile base units in Materico Rovere Chiaro. Thai Handle tall units in Seta matt lacquered.

Plan en Mineralux couleur Seta avec Vasque Gaia. Eléments bas Thai Gorge Materico Rovere Chiaro. Colennes Thai Poignée laquée Seta mat.

Waschtischplatte aus Mineralux Farbe Seta mit Ausgussbecken Gaia. Unterschränke Thai Griffprofil Materico Rovere Chiaro. Hochschranke Thai Griff Seta matt lackiert.

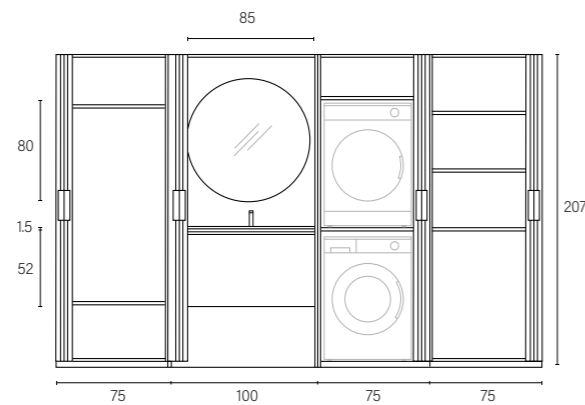

Top in Mineralux colore Cipria con Vasca Lavatoio Astra. Base Thai Line e colonne Thai Maniglia laccato Cipria opaco. Specchio Sole.

Mineralux Top in Cipria colour with Astra Washtub. Thai Line Base unit and Thai Handle tall units in Cipria matt lacquered. Sole mirror.

Plan en Mineralux couleur Cipria avec Vasque Astra. Thai Line Elément bas et colonnes Thai Poignée laqué Cipria mat. Miroir Sole.

Waschtischplatte aus Mineralux Farbe Cipria mit Ausgussbecken Astra. Unterschrank Thai Line und Hochschranke Thai Griff Cipria matt lackiert. Spiegel Sole.



Top in Mineralux colore Acquamarina con Vasca Lavatoio Gaia. Basi e colonna Thai Line Materico Talco.

Mineralux Top in Acquamarina colour with Gaia Washbasin. Thai Line base and tall units in Materico Talco.

Plan en Mineralux couleur Acquamarina avec Vasque Gaia. Eléments bas et colonnes Thai Line Materico Talco.

Waschtischplatte aus Mineralux Farbe Acquamarina mit Ausgussbecken Gaia. Unterschränke und Hochschrank Thai Line Materico Talco.

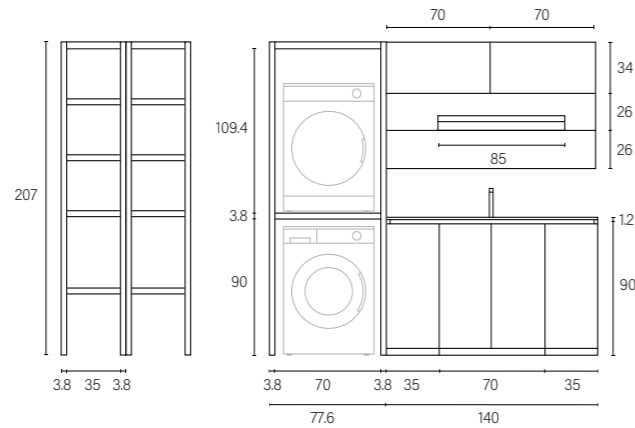

Top in Geacril® colore Verde Comodoro con Vasca Lavatoio B608. Pensili e Basi Thai Gola con ante laccato Nebbia opaco. Colonne a Giorno laccato Verde Comodoro opaco.

Geacril® Top in Verde Comodoro colour with Washtub B608. Thai Grip Profile wall and base units with Nebbia matt lacquered doors. Open tall units in Verde Comodoro matt lacquered.

Plan en Geacril® couleur Verde Comodoro avec Vasque B608. Eléments Hauts et Bas Thai Gorge avec portes en laqué Nebbia mat. Colonne ouverte laqué Verde Comodoro mat.

Waschtischplatte aus Geacril® Farbe Verde Comodoro mit ausgussbecken B608. Hängeschränke und Unterschränke Thai Griffprofil mit Türen Nebbia matt lackiert. Offene Hochschränke Verde Comodoro matt lackiert.

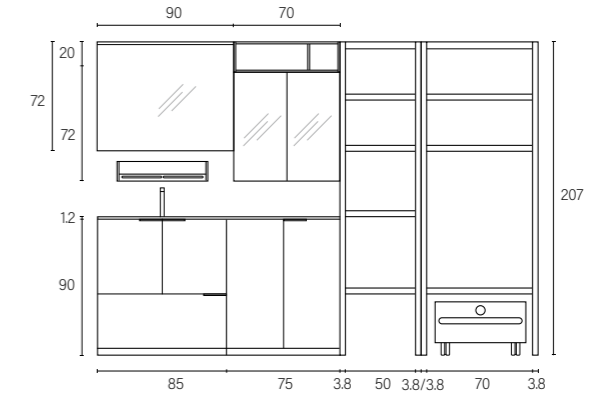

Top in Geacril® colore Nude con Vasca Lavatoio B505. Basi Thai Maniglia laccato Nude opaco. Colonne a Giorno Materico Roccia.

Geacril® top in Nude colour with washtub B505. Thai Handle base units in Nude matt lacquered. Open tall units in Materico Roccia.

Plan en Geacril® couleur Nude avec Vasque Evier B505. Elements bas Thai Poignée laqué Nude mat. Colonne ouverte en Materico Roccia.

Waschtischplatte aus Geacril® Farbe Nude mit Ausgussbecken B505. Unterschränke Thai Griff aus Nude matt lackiert. Offene Hochschränke aus Materico Roccia.

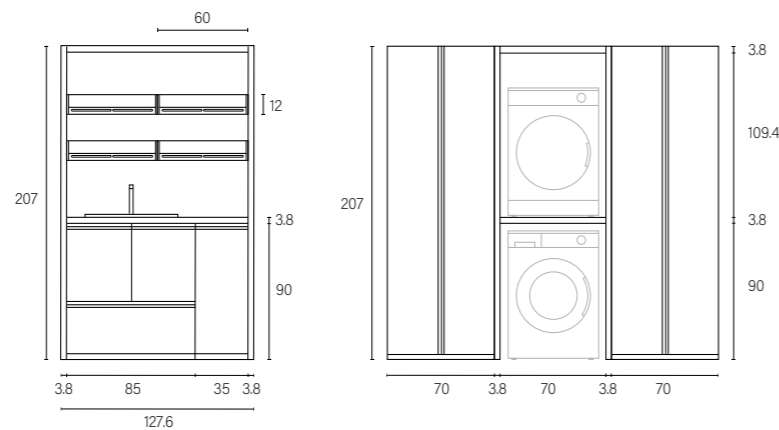

Struttura a giorno in HPL Selce. Lavatoio in ceramica Time. Basi Thai Line Materico Vaniglia. Mensole laccato Cacao Orinoco opaco.

HPL open structure in Selce colour. Time ceramic Washtub. Thai Line Base units in Materico Vaniglia. Shelves in Cacao Orinoco matt lacquered.

Structure ouverte en HPL Selce. Evier en céramique Time. Eléments bas Thai Line Materico Vaniglia. Etagères en laqué Cacao Orinoco mat.

Offene Struktur aus HPL Selce. Ausgussbecken aus Keramik Time. Unterschränke Thai Line aus Materico Vaniglia. Borde aus Cacao Orinoco matt lackiert.

Colonne Thai Line Materico Vaniglia. Struttura a Giorno laccato Cacao Orinoco opaco.

Thai Line tall units in Materico Vaniglia. Open structure in Cacao Orinoco matt lacquered.

Colonne Thai Line en Materico Vaniglia. Structure ouverte laqué Cacao Orinoco mat.

Hochschränke Thai Line aus Materico Vaniglia. Offene Struktur aus Cacao Orinoco matt lackiert.

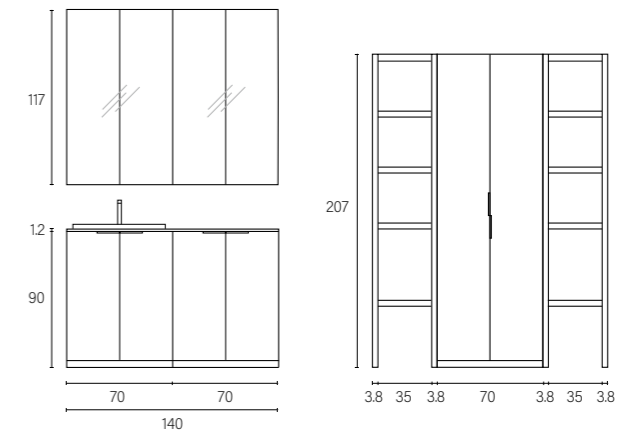

Top in HPL Brunito con Lavatoio in ceramica Time. Basi, Contenitore a Specchio e Colonne Thai Maniglia laccato Zenzero opaco. Colonne a giorno Materico Cannella.

Burnished HPL Top with Time ceramic Washtub. Base units, Mirror storage unit and Thai Handle tall units in Zenzero matt lacquered. Open tall units in Materico Cannella.

Plan en HPL Bruni avec Evier en céramique Time. Eléments bas, Élément de rangement à Miroir et Colonne Thai Poignée laqué Zenzero mat. Colonne ouverte en Materico Cannella.

Waschtischplatte aus HPL Brüniert mit Ausgussbecken aus Keramik Time. Unterschränke, Schrankelement Spiegel und Hochschränke Thai Griff aus Zenzero matt lackiert. Offene Hochschränke aus Materico Cannella.

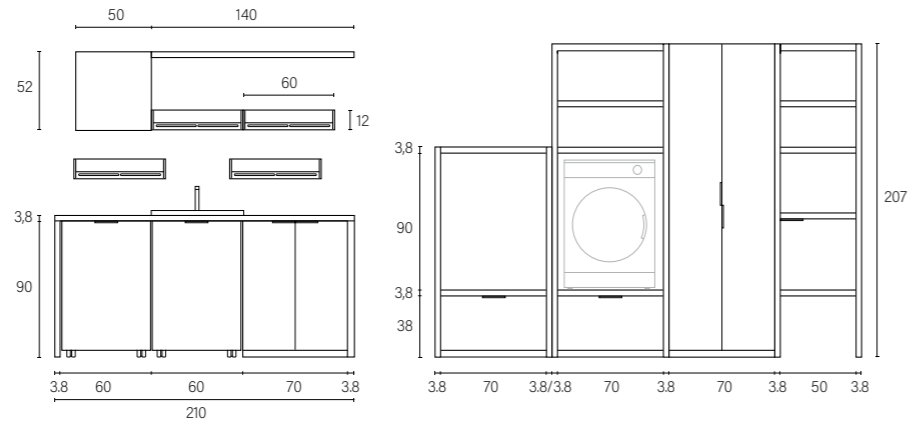

Strutture a Giorno Materico Roccia. Lavatoio in ceramica Time. Frontali Thai Maniglia Materico Deserto.

Open structures in Materico Roccia. Time ceramic Washtub. Thai Handle fronts in Materico Deserto.

Structures ouvertes en Materico Roccia. Evier en céramique Time. Façades Thai Poignée en Materico Deserto.

Offene Strukturen aus Materico Roccia. Ausgussbecken aus Keramik Time. Fronten Thai Griff aus Materico deserto.

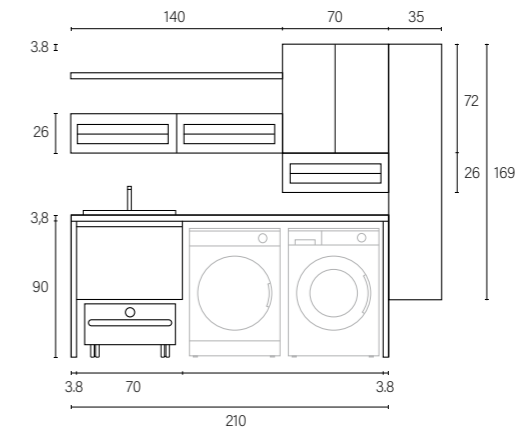

Strutture a Giorno Materico Rovere Chiaro con Lavatoio in Geacril® colore Piombo. Base e Pensili Thai Gola laccato Piombo opaco. Pannelli Materico Rovere Chiaro e Mensole in metallo laccato Piombo opaco con retro illuminazione a led.

Open structures in materico Rovere Chiaro with Idrá Washtub Geacril® in piombo colour. Thai Gola base and Wall unit in Piombo matt lacquered. Panels in Materico Rovere Chiaro and Metal shelves in Piombo matt lacquered with Led backlit.

Structures ouvertes en Materico Rovere Chiaro avec Evier Idrá en Geacril® couleur Piombo. Élément bas et Haut Thai Gola laqué Piombo mat. Panneaux en Materico Rovere Chiaro et Etagères en métal laqué Piombo mat avec éclairage led sur l'arrière.

Offener Struktur aus Materico Rovere Chiaro mit Ausgussbecken Idrá aus Geacril® Farbe Piombo. Unterschrank und Hängeschränke Thai Gola in Piombo matt lackiert. Platten aus Materico Rovere Chiaro und Borde aus Metall in Piombo matt lackiert mit LED-Hintergrundbeleuchtung.

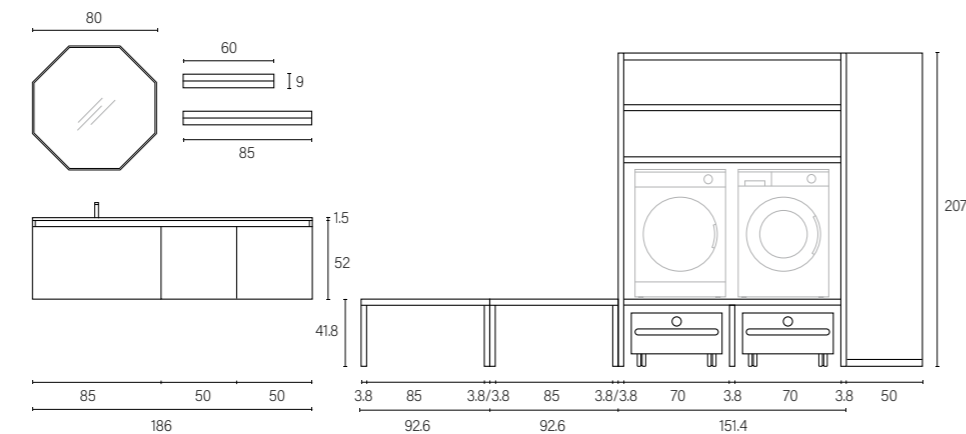

Top in Mineralux colore Nude con Vasca Lavatoio Astra. Basi Thai Gola laccato Pesca opaco. Mensole in metallo laccato Nude opaco. Specchio modello Sector. Strutture a Giorno Materico Malta.

Mineralux Top in Nude colour with Astra Washtub. Thai Grip Profile base units in Pesca matt lacquered. Metal shelves in Nude matt lacquered. Sector Mirror. Open structures in Materico Malta.

Plan en Mineralux couleur Nude avec Vasque Evier Astra. Éléments bas Thai Gorge en laqué Pesca mat. Etagères en métal laqué nude mat. Miroir Sector. Structures ouvertes en Materico Malta.

Waschtischplatte aus Mineralux Farbe Nude avec Ausgussbecken Astra. Unterschränke Thai Griffprofil Pesca matt lackiert. Borde aus Metall Nude matt lackiert. Spiegel Sector. Offene Strukturen aus Materico Malta.

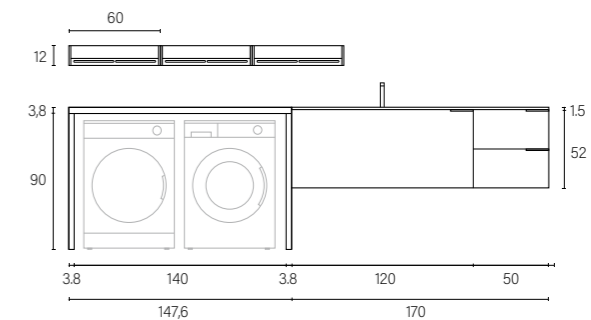

Top in Mineralux Bianco opaco con Vasca Lavatoio Gaia. Struttura a Giorno in HPL Spaccato. Basi Thai Maniglia laccato Bianco opaco. Mensole laccate Ardesia opaco.

Mineralux top in Mat Bianco with Gaia Washtub. HPL Open Structure. Thai Handle base units in Bianco matt lacquered. Shelves in Ardesia matt lacquered.

Plan en Mineralux Bianco mat avec Vasque Evier Gaia. Structure ouverte en HPL. Éléments bas Thai Poignée laqué Bianco mat. Etagères en laqué Ardesia mat.

Waschtischplatte aus Mineralux Bianco mit Ausgussbecken Gaia. Offene Struktur aus HPL. Unterschränke Thai Griff in Bianco matt lackiert. Borde aus Ardesia matt lackiert.

LAV513

pagina/page 96

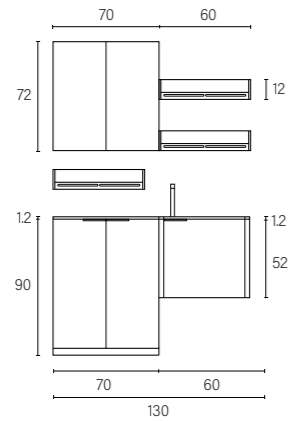

Top in Geacril® Bianco lucido con Vasca Lavatoio B372. Basi Thai Maniglia laccato Cemento opaco. Pensile laccato Grigio Efeso opaco.

Geacril® Top in Glossy White with Washtub B372. Thai Handle base units in Cemento matt lacquered. Wall unit in Grigio Efeso matt lacquered.

Plan en Geacril® en Bianco brillant avec Vasque Evier B372. Eléments bas Thai Poignée laqué Cemento mat. Elément haut laqué Grigio Efeso mat.

Waschtischplatte aus Geacril® in Glänzend Bianco mit Ausgussbecken B372. Unterschränke Thai Griff in Cemento matt lackiert. Hängeschrank in Grigio Efeso matt lackiert.





Perla Metallizzato Argento Metallizzato Titanio Metallizzato Sabbia Metallizzato Ottone Metallizzato Bronzo Metallizzato



Metal



Brunito

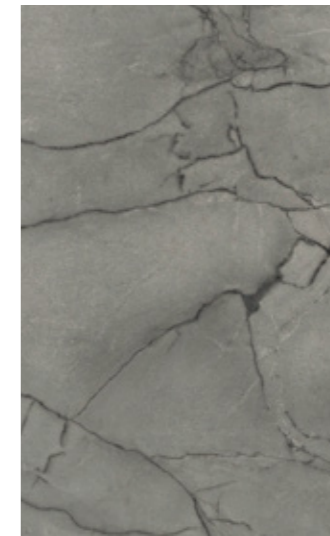

Spaccato

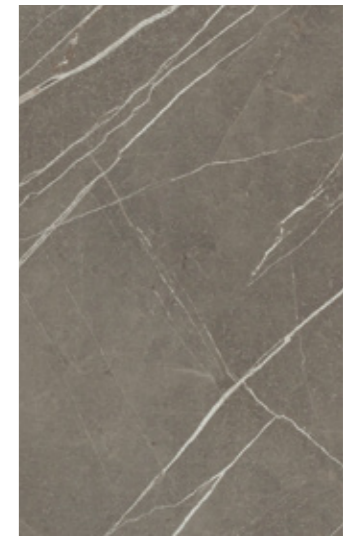

Selce

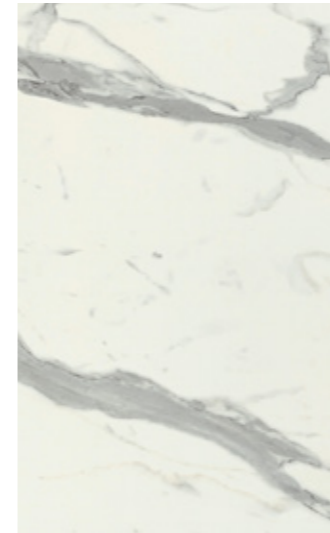

Statuario

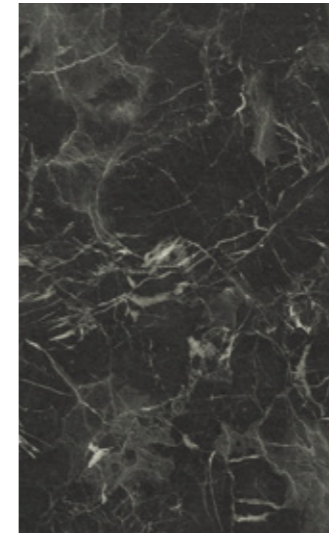

Canyon

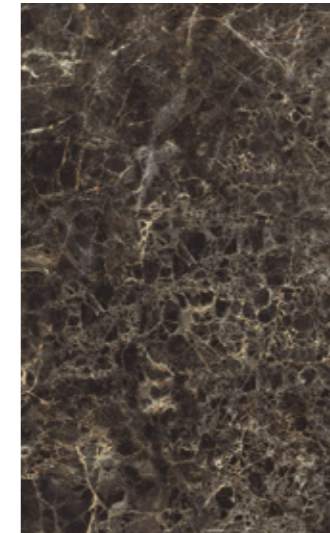

Cuba



Corten



Gold



Primitivo



Fossile

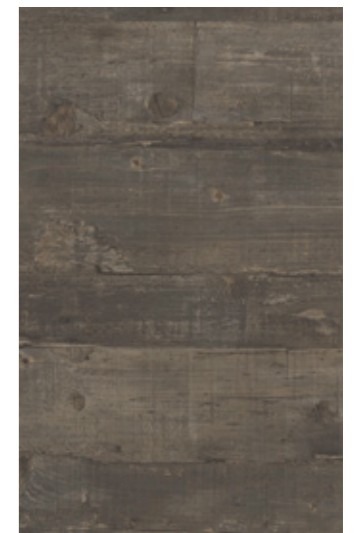

Carbon



Talco



Deserto



Vulcano

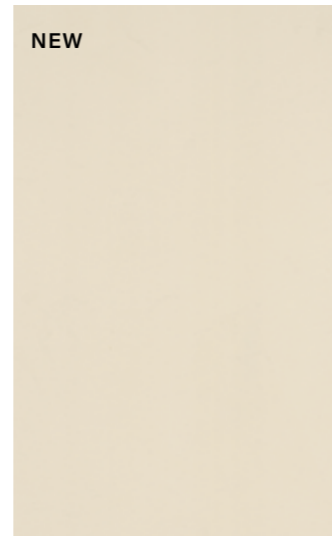

Vaniglia



Piacentina Cenere



Piacentina Beige

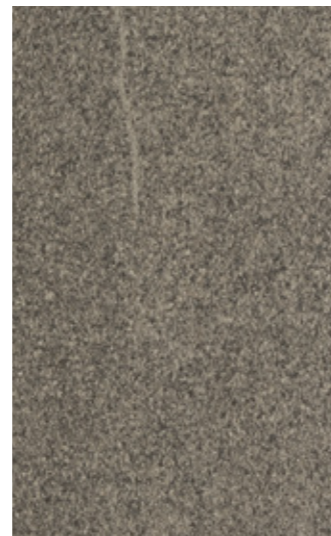

Piacentina Grigia



Roccia



Malta



Basalto

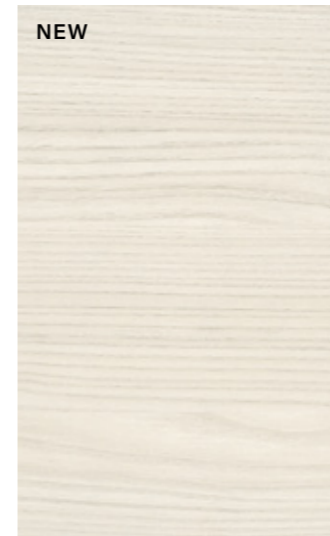

Papiro

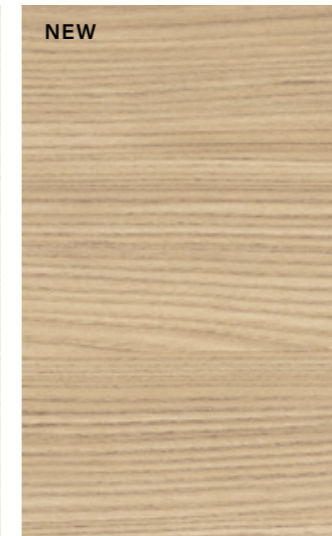

Rovere Chiaro

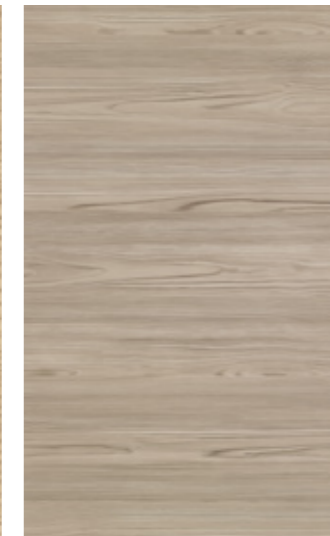

Lino



Visone



Rovere Oslo



Cannella

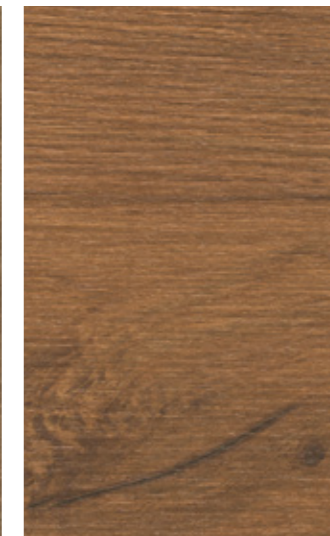

Kenya



Nilo



Rovere Bruciato



Noce Rigato

Design **UFFICIO TECNICO RAB**,
A.D. **MAURA SANTAROSSA** con la collaborazione di Michele Guerra e Alessandro Paolin
Graphic **LISA LONGO**, Colour separation **INCOLOR**, Print **IMOCO**

Stampato in Ottobre 2023

Thanks to: **ARTIS Srl**

PER LA REALE TONALITÀ DEI COLORI FARE RIFERIMENTO AL CAMPIONARIO. LE IMMAGINI E I DATI CONTENUTI NEL PRESENTE CATALOGO SONO DA RITENERSI INDICATIVI E POSSONO SUBIRE VARIAZIONI ANCHE SENZA PREAVVISO.

FOR THE REAL COLOR SHADE, SEE RAB COLOR CHART. IMAGES AND DATA CONTAINED IN THIS CATALOGUE ARE TO BE CONSIDERED INDICATIVE AND MAY BE CHANGED WITHOUT ANY NOTICE.

CONSULTER LE CATALOGUE DES ÉCHANTILLONS POUR LA NUANCE EXACTE DES COULEURS. LES IMAGES ET LES DONNÉES CONTENUES DANS LE PRÉSENT CATALOGUE DOIVENT ÊTRE CONSIDÉRÉES COMME INDICATIVES, ELLES PEUVENT SUBIR DES VARIATIONS SANS AUCUN PRÉAVIS.

FÜR DIE TATSÄCHLICHEN FARBTÖNE SEHEN SIE BITTE IN UNSEREM MUSTERBUCH NACH. DIE IN DIESEM KATALOG ENTHALTENEN BILDER UND DATEN HABEN NUR UNGEFÄHREN CHARAKTER UND KÖNNEN AUCH OHNE VORHERIGE MITTEILUNG ÄNDERUNGEN UNTERLIEGEN.

RAB[®]
DESIGN FOR BATHROOMS

www.rabarredobagno.com - info@rabarredobagno.com