

DESIGN
FOR
BATHROOM
THAI



RAB

THAI

NEW COLLECTION

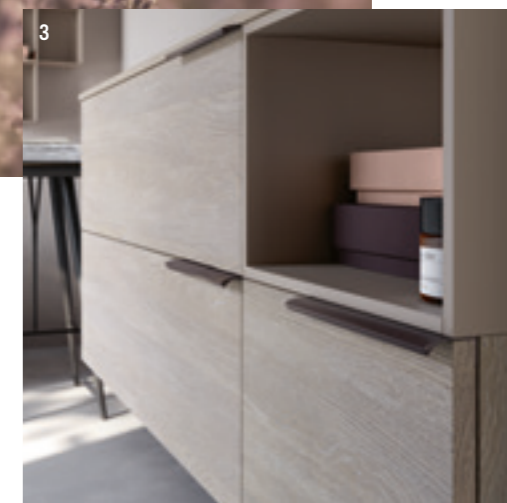
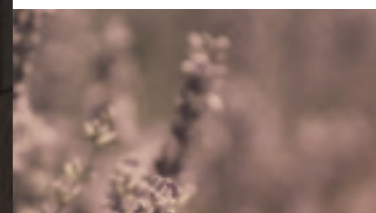

SISTEMI DI APERTURA OPENING SYSTEMS

- 1. **GOLA** / GRIP PROFILE
- 2. **PRESA DIRETTA** / GRIP OPENING
- 3. **MANIGLIA** / HANDLE
- 4. **POMOLO** / ROUND KNOB



L'IDEA? SAPER GUARDARE OLTRE

IL BAGNO PER
CREARE UN ARREDO
UNICO E PERSONALE
CHE DIALOGA CON LO
SPAZIO CIRCOSTANTE.
SPERIMENTARE NUOVI
ACCOSTAMENTI DI
FORME E MATERIALI

THE IDEA? TO LOOK BEYOND THE
BATHROOM AND CREATE A UNIQUE,
PERSONAL DÉCOR THAT BLENDS IN WITH
THE SURROUNDING SPACE. EXPERIMENT
MATCHING MATERIALS AND SHAPES.



THAI
310
P.04



THAI
318
P.76



THAI
319
P.88



THAI
320
P.98



THAI
311
P.14



THAI
321
P.108

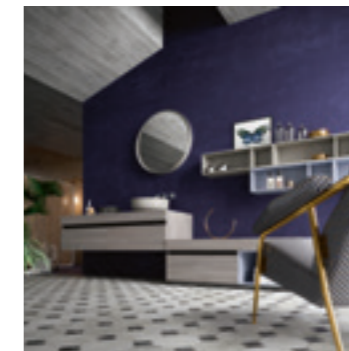

THAI
322
P.116



THAI
323
P.126



THAI
312
P.26

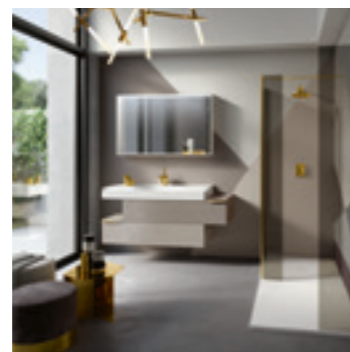

THAI
313
P.32



THAI
314
P.40



THAI
324
P.130



THAI
325
P.138



THAI
315
P.50



THAI
316
P.60



THAI
317
P.68



THAI
326
P.146

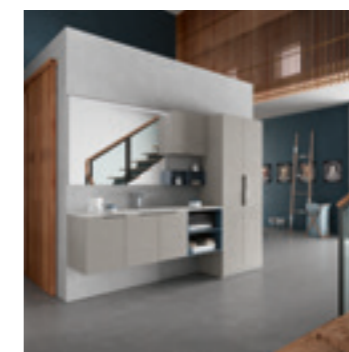

THAI
327
P.154

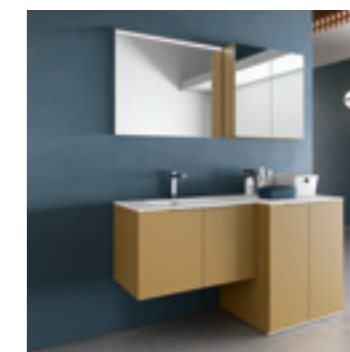

THAI
328
P.180

UN DINAMICO MOVIMENTO GRAFICO

L'ALTERNANZA TRA
PIANI, VOLUMI,
SPESSORI E MATERIALI
DIVERSI DEFINISCE
LA COMPOSIZIONE;
UNA SOLUZIONE
FLESSIBILE E ALTAMENTE
PERSONALIZZABILE.

A DYNAMIC GRAPHIC EFFECT. ALTERNATING
TOPS, VOLUMES, THICKNESSES AND DIFFERENT
MATERIALS CREATE A GRAPHIC STATEMENT THAT
DEFINES THE COMPOSITION; A WONDERFULLY
CUSTOMISABLE, FLEXIBLE SOLUTION.

THAI **310**









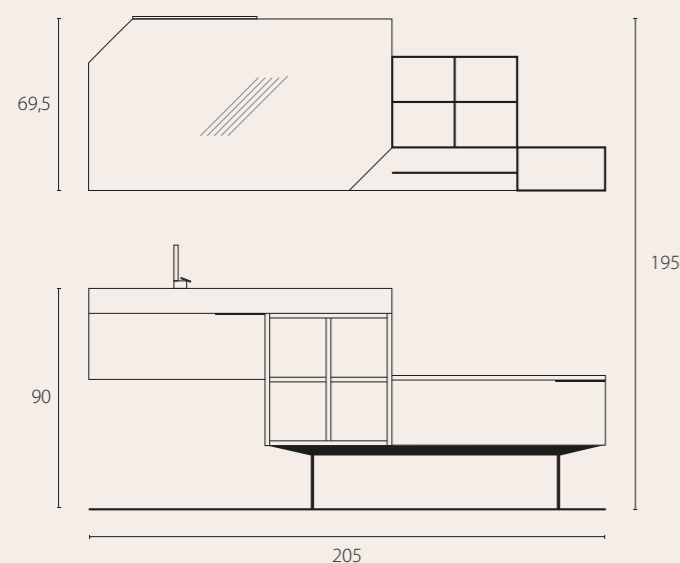

Profondità: 50 cm

DESCRIZIONE DESCRIPTION

Top H 12 cm in Mineralux Stone Panna con vasca Alfa.

Basi in Materico Lino C940 su Panca in metallo nero, Maniglie in metallo nero. Base a giorno laccato opaco Panna C02.

Pensili a giorno laccato opaco Panna C02.

Pannello diagonale in Materico Lino C940 con Mensola in metallo laccata opaco Panna C02.

Specchiera Corner con profilo nero spazzolato, lampada led Veletta.

EN. Top H 12 cm in Mineralux Stone Panna with Alfa bowl. Base units in Materico Lino C940 on black metal Bench, black metal Handles. Open base unit in matt lacquered Panna C02. Open wall units in matt lacquered Panna C02. Diagonal panel in Materico Lino C940 with Metal shelf in matt lacquered Panna C02. Corner mirror with brushed black profile, Veletta led lamp.

FR. Plan H 12 cm en Mineralux Stone Panna avec cuve Alfa. Éléments bas en Materico Lino C940 sur Panc en métal noir, Poignées en métal noir. Élément bas ouvert laqué mat Panna C02. Éléments hauts ouverts laqué mat Panna C02. Panneau diagonal en Materico Lino C940 avec Etagère en métal laqué mat Panna C02. Miroir Corner avec profil noir brossé, lampe led Veletta.

ES. Encimera H 12 cm de Mineralux Stone Panna con pila Alfa. Muebles bajos de Materico Lino C940 en Banco de metal negro, Tiradores de metal negro. Mueble bajo abierto lacado mate Panna C02. Muebles colgantes abiertos lacado mate Panna C02. Panel diagonal de Materico Lino C940 con Repisa de metal lacada mate Panna C02. Espejo Corner con perfil negro cepillado, lampàra led Veletta.

DE. Waschtischplatte H 12 cm aus Mineralux Stone Creme mit Waschbecken Alfa Unterschränke in Materico Lino C940 auf Gestell aus schwarzem Metall, Griffe aus schwarzem Metall. Offener Unterschrank in Lack Matt Panna C02. Offene Hängeschränke in Lack Matt Panna C02. Diagonale Platte in Materico Lino C940 mit Ablagebord aus matt lackiertem Metall in Panna C02. Spiegel Corner mit gebürstetem schwarzem Profil, LED-Lampe Veletta.

RU. Столешница В.12 см из in Mineralux Stone Panna с раковиной Alfa. Напольные шкафы в отделке Materico Lino C940 на черных металлических ножках. Металлические черные ручки. Открытое отделение в матовой лакировке Panna C02. Навесные открытые шкафы в МАТОВОЙ ЛАКИРОВКЕ Panna C02. Диагональная панель в отделке Materico Lino C940 с полкой из металла в матовой лакировке Panna C02. Зеркало Corner с брашированным черным профилем, светодиодный светильник Veletta.



MATERIALI MATERIALS

1. MATERICO LINO C940
2. LACCATO OPACO PANNA C02
3. MINERALUX STONE PANNA



SPECCHIERA MIRRORS

CORNER con lampada led VELETTA.
CORNER with VELETTA led lamp.



LAVABO WASHBASIN

Top h 12 cm in Mineralux Stone Panna con vasca integrata Alfa.
Top h 12 cm in Mineralux Stone Panna With Alfa integrated bowl.

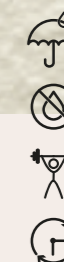

LA PUREZZA DELLA MATERIA

I COLORI DENSI SCELTI
NELLE TONALITÀ A
CONTRASTO E LE
NUOVE TEXTURE
MATERICHE CATTURANO
L'ATTENZIONE RISPETTO
ALLA PERCEZIONE DEI
VOLUMI.

PURE TEXTURES AND DENSE COLOURS IN
CONTRASTING SHADES DRAW ATTENTION TO
PERCEIVED VOLUMES.

THAI 311











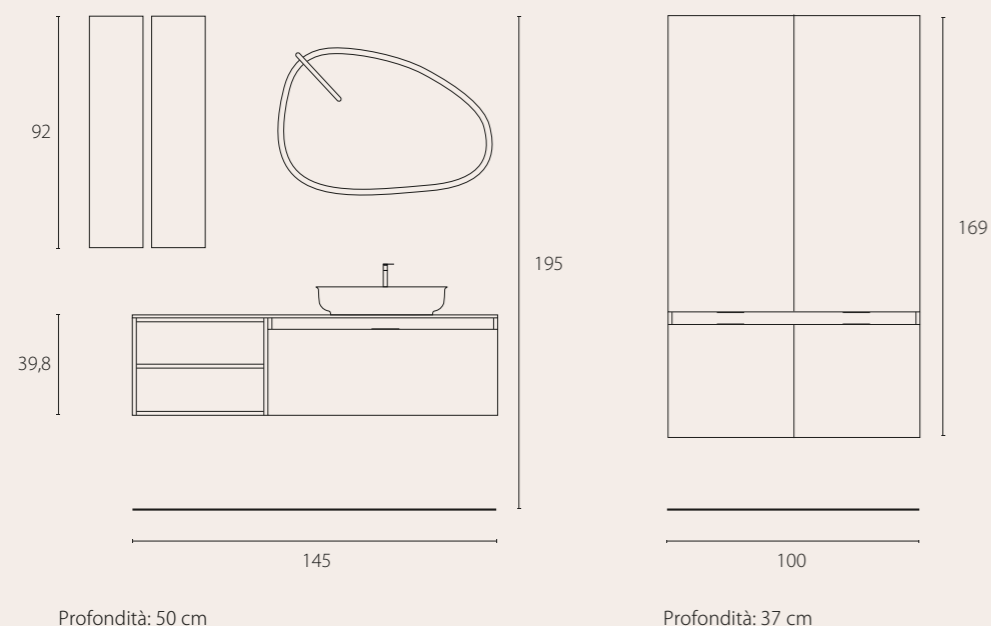

Profondità: 50 cm

Profondità: 37 cm

DESCRIZIONE DESCRIPTION

Top sp. 1,8 cm in Materico Deserto C910, lavabo Joy in Mineralux Antracite.
Base in Materico Basalto C930, apertura presa diretta. Base a giorno in Materico Deserto C910.
Pensili girevoli in metallo laccato opaco Ardesia C06.
Specchiera Opale retroilluminata, lampada led Bianca.
Colonne in Materico Basalto C930, apertura presa diretta.

EN. 1.8 cm th. Top in Materico Deserto C910, Joy washbasin in Mineralux Antracite. Base unit in Materico Basalto C930, grip opening. Open base unit in Materico Deserto C910. Swivel metal wall units in matt lacquered Ardesia C06. Opale back lit mirror, Bianca led light. Tall unit in Materico Basalto C930, grip opening.

FR. Plan ép. 1,8 cm en Materico Deserto C910, lavabo Joy en Mineralux Antracite. Élément bas en Materico Basalto C930, ouverture prise directe. Élément bas ouvert en Materico Deserto C910. Élément hauts pivotants en métal laqué mat Ardesia C06. Miroir Opale rétroéclairé, lampe led Blanche. Colonnes en Materico Basalto C930, ouverture prise directe.

ES. Encimera esp. 1,8 cm de Materico Deserto C910, lavabo Joy de Mineralux Antracite. Mueble bajo de Materico Basalto C930, apertura presa directa. Mueble bajo abierto de Materico Deserto C910. Muebles colgantes giratorios de metal lacado mate Ardesia C06. Espejo Opale retroiluminado, lámpara led Bianca. Columnas de Materico Basalto C930, apertura presa directa.

DE. Waschtischplatte St. 1,8 cm in Materico Deserto C910, Waschbecken Joy aus Mineralux Antracite. Unterschrank in Materialoptik Basalt C930, mit Griffmulde. Offener Unterschrank in Materico Deserto C910. Schwenkbare Hängeschränke aus matt lackiertem Metall in Ardesia C06. Hinterleuchteter Spiegel Opale, LED-Lampe Weiß. Hochschränke in Materico Basalto C930, mit Griffmulde.

RU. Столешница толщиной 1,8 см в отделке Materico Deserto C910. Раковина Joy из Mineralux Antracite. Нижний шкаф в отделке Materico Basalto C930, встроенная в верх фасада ручка. Открытое отделение в отделке Materico Deserto C910. Вращающиеся навесные шкафы из металла в матовой лакировке Ardesia C06. Зеркало Opale с подсветкой с обратной стороны, светодиодный светильник Bianca. Высокие шкафы в отделке Materico Basalto C930, встроенная в верх фасада ручка.



MATERIALI MATERIALS

1. MATERICO BASALTO C930
2. MATERICO DESERTO C910
3. LACCATO OPACO ARDESIA C06

SPECCHIERA MIRRORS

OPALE retroilluminata con lampada led BIANCA.
OPALE back lit with BIANCA led light.

LAVABO WASHBASIN

Lavabo JOY in Mineralux Antracite.
JOY washbasin in Mineralux Antracite.

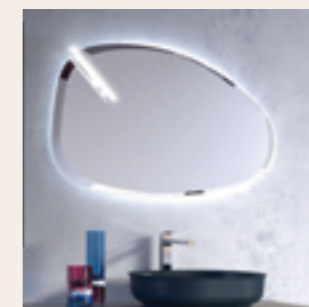
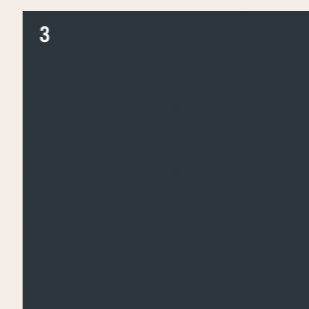

STILE APERTO ALLE CONTAMINAZIONI

LA TEXTURE MATERICA
CON LE SUE CALDE
VENATURE IRROMPE E
RAVVIVA L'ATMOSFERA
INDUSTRIAL DAI TONI
SCURI E AVVOLGENTI.

STYLE OPEN TO CONTAMINATION. STYLE GIVING
IN TO UNABASHED TEXTURE CONTAMINATION
WITH WARM GRAIN THAT LIVENS THE DARK,
ENVELOPING INDUSTRIAL ATMOSPHERE.

THAI **312**







THAI 312

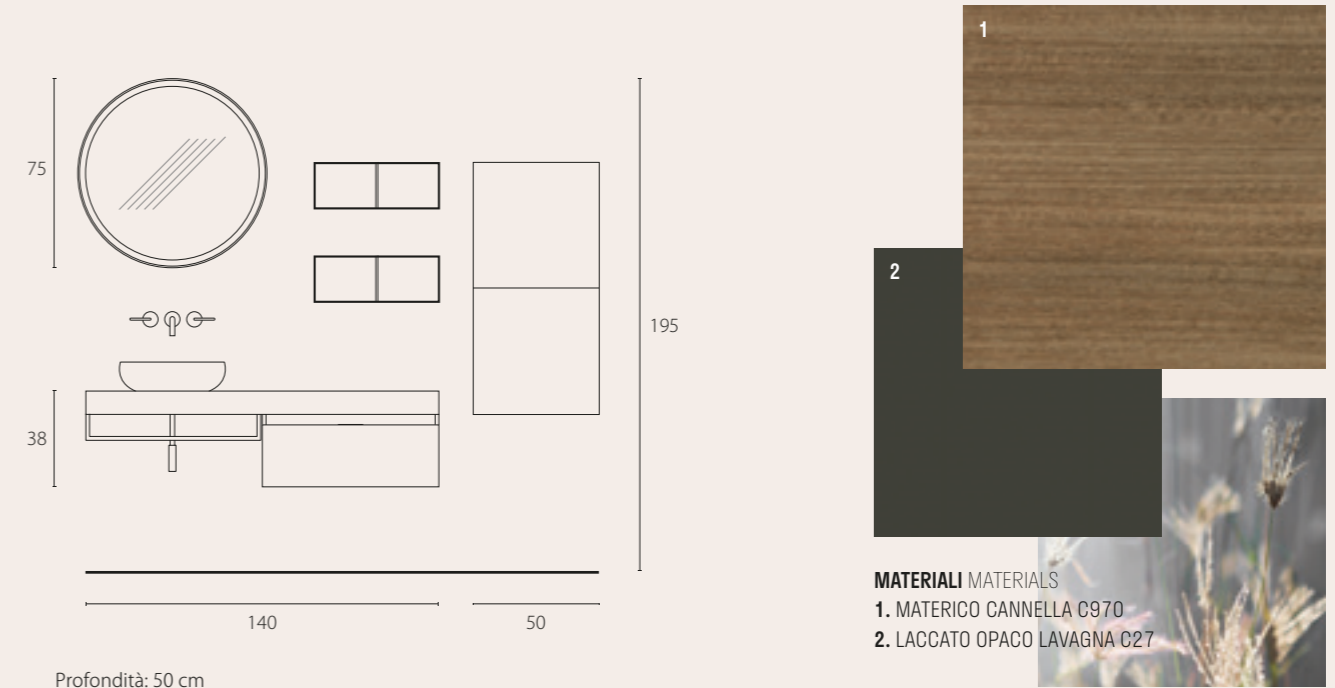

Profondità: 50 cm

DESCRIZIONE DESCRIPTION

Top H 10 cm in Materico Cannella C970. Lavabo Botero in Mineralux Bianco. Porta salviette in metallo laccato opaco Nero C82. Base con gola in laccato opaco Lavagna C27. Pensile in laccato opaco Lavagna C27. Elementi a giorno in metallo laccato opaco Lavagna C27. Specchiera Metal con cornice in metallo laccato opaco Lavagna C27.

EN. H 10cm Top in Materico Cannella C970. Botero washbasin in Mineralux Bianco. Metal Towel rail in Matt lacquered Nero C82. Base unit with grip profile in matt lacquered LavagnaC27. Wall unit in matt lacquered Lavagna C27. Open elements in matt lacquered metal Lavagna C27. Metal mirror with frame in matt lacquered metal Lavagna C27.

FR. Plan H 10 cm en Materico Cannella C970. Lavabo Botero en Mineralux Bianco. Porte-serviettes en métal laqué mat Nero C82. Élément bas avec gorge en laqué mat Lavagna C27. Élément haut en laqué mat Lavagna C27. Éléments ouverts en métal laqué mat Lavagna C27. Miroir Metal avec cadre en métal laqué mat Lavagna C27.

ES. Encimera H 10 cm de Materico Cannella C970. Lavabo Botero de Mineralux Bianco. Toallero de metal lacado mate Nero C82. Mueble bajo con perfil rebajado de lacado mate Lavagna C27. Mueblecolgante de lacado mate Lavagna C27. Elementos abiertos de metal lacado mate Lavagna C27. Espejo Metal con marco de metal lacado mate Lavagna C27.

DE. Waschtischplatte H 10 cm in Materico Cannella C970. Waschbecken Botero aus Mineralux Weiß. Handtuchhalter aus matt lackiertem Metall in Nero C82. Unterschrank mit Hohlkehle in Lack Matt Lavagna C27. Hängeschränke in Lack Matt Lavagna C27. Offene Elemente aus matt lackiertem Metall in Lavagna C27. Spiegel Metal mit Rahmen aus matt lackiertem Metall in Lavagna C27.

RU. Столешница В. 10 см в отделке Materico Cannella C970. Раковина Botero из Mineralux Bianco. Держатель для полотенец из металла в матовой лакировке Nero C82. Нижний шкаф с ручкой-углубления в матовой лакировке Lavagna C27. Навесной шкаф в матовой лакировке Lavagna C27. Открытые отделения из металла в матовой лакировке Lavagna C27. Зеркало Metal в раме из металла в матовой лакировке Lavagna C27.

**NUOVI MODI DI
INTERPRETARE
IL PROGETTO BAGNO**

ANCHE POCHI
ELEMENTI ASSICURANO
SOLUZIONI ORIGINALI
E PROPORZIONI
BILANCIATE PER UN
RISULTATO D'EFFETTO.

NEW WAYS TO INTERPRET BATHROOM PROJECTS.
JUST A FEW ELEMENTS PROVIDE ORIGINAL
SOLUTIONS AND BALANCED PROPORTIONS THAT
MAKE A TRUE STATEMENT.

THAI **313**





THAI

**LE DUE PASTOSE
TONALITÀ IN NUANCE
DELLE BASI SONO
IMPREZIOSITE DALLA
LUMINOSITÀ DEGLI
ACCESSORI IN
OTTONE SPAZZOLATO.**

THE TWO CREAMY SHADES
OF THE BASE UNITS ARE
ENHANCED BY THE LUMINOUS
ACCESSORIES IN BRUSHED
BRASS.





THAI 313

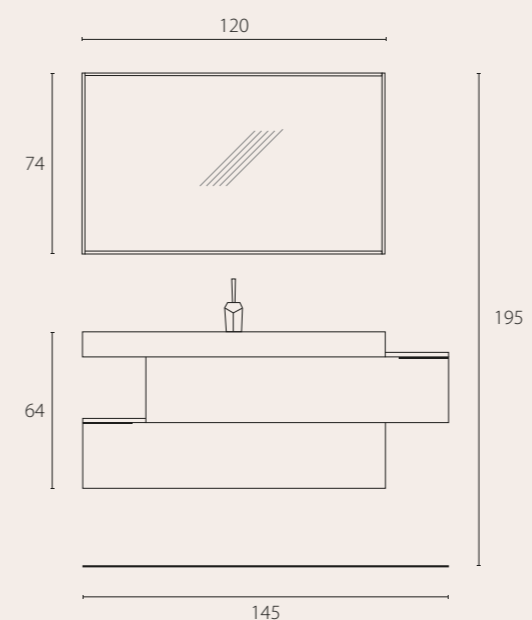

Profondità: 50 cm



MATERIALI MATERIALS
1. MATERICO DESERTO C910
2. MATERICO VULCANO C920
3. MINERALUX STONE BIANCO

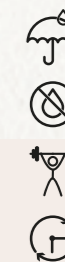

DESCRIZIONE DESCRIPTION

Top H 12 cm in Mineralux Stone Bianco con vasca Alfa. Basi in Materico Vulcano C920 e Deserto C910, Maniglie in metallo Ottone. Specchiera Square laccata opaco Bianco C01. Piatto doccia Flatsystem in Mineralux Bianco.

EN. H 12cm Top in Mineralux Stone Bianco with Alfa bowl. Base units in Materico Vulcano C920 and Deserto C910. Handle in Brass metal. Square mirror in matt lacquered Bianco C01. Flatsystem shower tray in Mineralux Bianco.

FR. Plan H 12 cm en Mineralux Stone Bianco avec cuve Alfa. Éléments bas en Materico Vulcano C920 et Deserto C910. Poignée en métal Ottone. Miroir Square laqué mat Bianco C01. Bac de douche Flatsystem en Mineralux Bianco.

ES. Encimera H 12 cm de Mineralux Stone Bianco con pila Alfa. Muebels bajos de Materico Vulcano C920 y Deserto C910. Tirador de metal Ottone. Especjo Square lacado mate Bianco C01. Plato de ducha Flatsystem de Mineralux Bianco.

DE. Waschtischplatte H 12 cm aus Mineralux Stone Weiß mit Waschbecken Alfa. Unterschränke in Materico Vulcano C920 und Materico Deserto C910. Griff aus Metall in Ottone. Spiegel Square in Lack Matt Bianco C01. Duschwanne Flatsystem aus Mineralux Bianco.

RU. Столешница В. 12 см из Mineralux Stone Bianco с раковиной Alfa. Нижние шкафы в отделке Materico Vulcano C920 и Deserto C910. Ручка из металла Ottone. Зеркало Square в матовой лакировке Bianco C01. Поддон Flatsystem из Mineralux Bianco.

UN UNICO SUGGESTIVO LINGUAGGIO

LO SPAZIO È
DISTRIBUITO IN
ORIZZONTALE E DIVISO
EQUAMENTE PER DUE.
LA MANIGLIA TONDA
DIVENTA ANCHE PRATICO
PORTA SALVIETTE.

A SINGLE EVOCATIVE LANGUAGE. SPACE IS
DISTRIBUTED HORIZONTALLY AND DIVIDED
EQUALLY INTO TWO. THE ROUND HANDLE ALSO
ACTS AS A PRACTICAL TOWEL RAIL.

THAI **314**









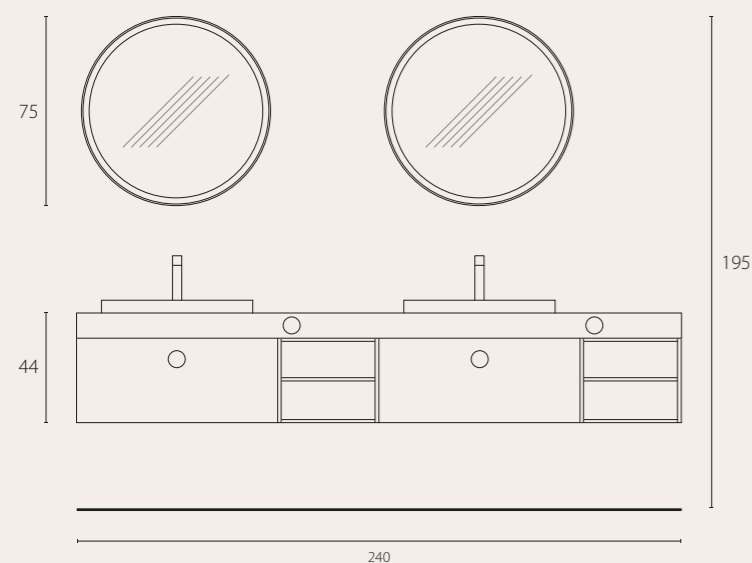

Profondità: 50 cm

DESCRIZIONE DESCRIPTION

Top H 10 in Materico Carbone C960. Lavabi Elisa in Mineralux Bianco.
Basi in Materico Visone C950 con elementi a giorno in Materico Carbone C960, Pomolo in metallo Bronzo.
Specchiere Metal con cornice in metallo laccato Bianco.

EN. H 10cm Top in Materico Carbone C960. Elisa washbasins in Mineralux Bianco. Base units in Materico Visone C950 with open elements in Materico Carbone C960, Metal knob Bronzo. Metal mirrors with frame in White lacquered metal.

FR. Plan H 10 en Materico Carbone C960. Lavabos Elisa en Mineralux Bianco. Eléments bas en Materico Visone C950 avec éléments ouverts en Materico Carbone C960, Bouton en métal Bronzo. Miroirs Metal avec cadre en métal laqué Blanc.

ES. Encimera H 10 de Materico Carbone C960. Lavabos Elisa de Mineralux Bianco. Muebles bajos de Materico Visone C950 con elementos abiertos de Materico Carbone C960, Pomo de metal Bronzo. Espejos Metal con marco de metal lacado Blanco.

DE. Waschtischplatte H 10 in Materico Carbone C960. Waschbecken Elisa aus Mineralux Bianco Unterschränke in Materico Visone C950, mit offene Elemente in Materico Carbone C960, Knauf aus Metall Bronzo. Spiegel Metal mit Rahmen aus weiß lackiertem Metall.

RU. Столешница В. 10 в отделке Materico Carbone C960. Раковины Elisa из Mineralux Bianco. Нижние шкафы в отделке Materico Visone C950 с открытыми элементами в отделке Materico Carbone C960. Круглые ручки из металла Bronzo. Зеркало Metal с рамой из металла в лакировке Bianco.

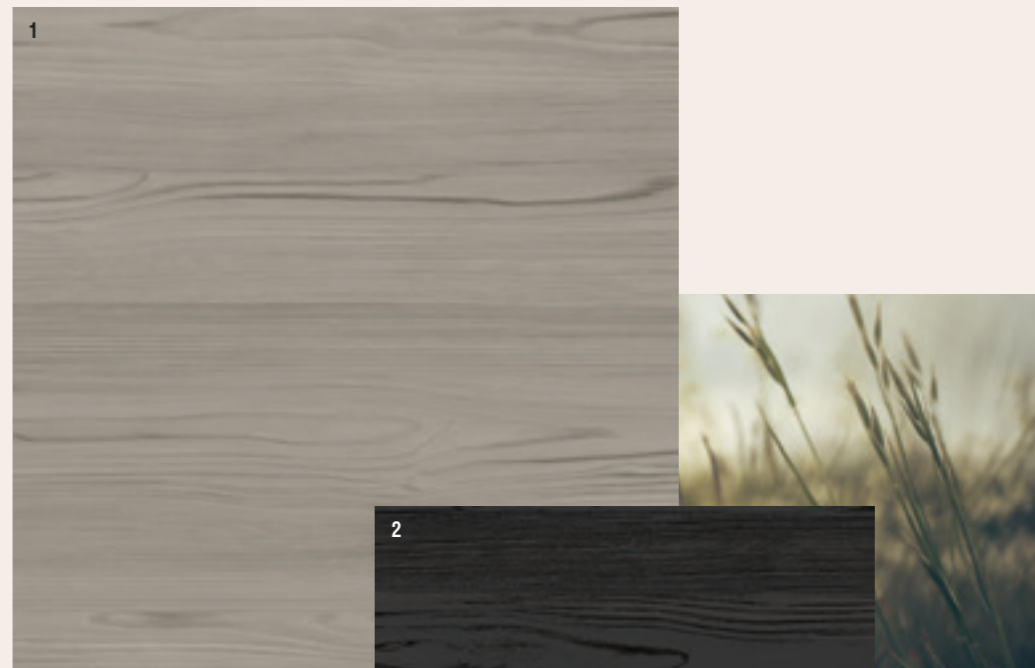

MATERIALI MATERIALS

1. MATERICO VISONE C950
2. MATERICO CARBONE C960

SPECCHIERA MIRRORS

METAL con cornice in metallo laccato bianco.
METAL with frame in white lacquered.

LAVABO WASHBASIN

Lavabi Elisa in Mineralux Bianco.
Elisa washbasins in Mineralux Bianco.

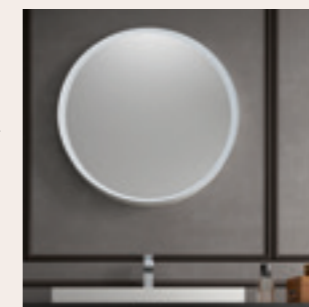

ECLETTICHE **GEOMETRIE**

L'ASSETTO DEGLI
ELEMENTI PENSILI
È STUDIATO PER
ASSECONDARE LO
SPECCHIO CORNER.
CON I SUOI PROFILI
INCLINATI CARATTERIZZA
FORTEMENTE LA
COMPOSIZIONE.

ECLECTIC GEOMETRY. THE WALL UNITS ARE
DESIGNED TO ACCOMMODATE THE CORNER
MIRROR WITH INCLINED PROFILES THAT
STRONGLY DISTINGUISHES THE COMPOSITION.

THAI **315**









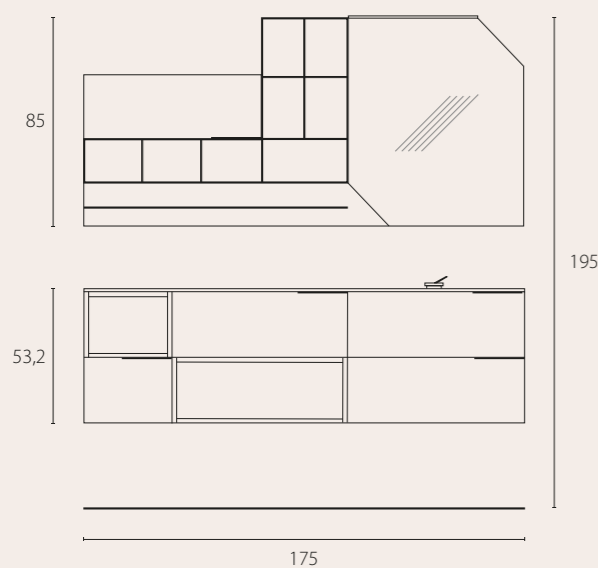

Profondità : 50 cm

DESCRIZIONE DESCRIPTION

Top sp. 1,2 cm in Tecnoril® Bianco con vasca Scivolo. Base in Materico Cannella C970, Maniglie in metallo Nero. Base a giorno in Materico Talco C900. Pensile in Materico Talco C900, elementi a giorno in metallo laccato opaco Ardesia C06. Pannello diagonale in Materico Cannella C970 con Mensola in metallo laccato opaco Ardesia C06. Specchiera Corner con profilo nero spazzolato e lampada led Veletta. Piatto doccia Flatsystem in Mineralux Antracite. Panca in metallo nero con top H10 cm in Materico Cannella C970.

EN. 1.2cm th.Top in Tecnoril® Bianco with Scivolo bowl. Base unit in Materico Cannella C970, Handles in Black metal. Open base unit in Materico Talco C900. Wall unit in Materico Talco C900, open elements in matt lacquered metal Ardesia C06. Diagonal panel in Materico Cannella C970 with Shelf in matt lacquered metal Ardesia C06. Corner Mirror with brushed black profile and Veletta led lamp. Flatsystem shower tray in Mineralux Antracite. Bench in black metal with top H10 cm in Materico Cannella C970.

FR. Plan ép. 1,2 cm en Tecnoril® Bianco avec cuve Scivolo. Élément bas en Materico Cannella C970, Poignées en métal noir. Élément bas ouvert en Materico Talco C900. Élément haut en Materico Talco C900, éléments ouverts en métal laqué mat Ardesia C06. Panneau diagonal en Materico Cannella C970 avec Etagère en métal laqué mat Ardesia C06. Miroir Corner avec profil noir brossé et lampe led Veletta. Bac de douche Flatsystem en Mineralux Antracite. Banc en métal noir avec plan H10 cm en Materico Cannella C970.

ES. Encimera esp. 1,2 cm de Tecnoril® Bianco con pila Scivolo. Mueble bajo de Materico Cannella C970, Tiradores de metal negro. Mueble bajo abierto de Materico Talco C900. Mueble colgante de Materico Talco C900, elementos abiertos de metal lacado mate Ardesia C06. Panel diagonal de Materico Cannella C970 con Repisa de metal lacado mate Ardesia C06. Espejo Corner con perfil negro cepillado y lámpara led Veletta. Plato de ducha Flatsystem de Mineralux Antracite. Banco de metal negro con encimera H10 cm de Materico Cannella C970.

DE. Waschtischplatte St. 1,2 cm aus Tecnoril in Bianco mit Waschbecken Scivolo. Unterschrank in Materico Cannella C970, Griffe aus schwarzem Metall. Offener Unterschrank in Materico Talco C900. Hängeschrank in Materico Talco C900, offene Elemente aus matt lackiertem Metall in Ardesia C06. Diagonale Platte in Materico Cannella C970 mit Ablagebord aus matt lackiertem Metall in Ardesia C06. Spiegel Corner mit gebürstetem schwarzem Profil und LED-Lampe Veletta. Duschwanne Flatsystem aus Mineralux Antracite. Gestell aus schwarzem Metall mit Waschtischplatte H10 cm in Materico Cannella C970.

RU. Столешница толщиной 1,2 см из Tecnoril® Bianco с раковиной Scivolo. Нижний шкаф в отделке Materico Cannella C970. Черные металлические ручки. Открытое отделение в отделке Materico Talco C900. Навесной шкаф в отделке Materico Talco C900, открытые элементы из металла в матовой лакировке Ardesia C06. Диагональная панель в отделке Materico Cannella C970 с полкой из металла в матовой лакировке Ardesia C06. Зеркало Corner черным брашированным профилем и светодиодным светильником Veletta. Душевой поддон Flatsystem из Mineralux Antracite. Черные металлические ножки со столешницей В.10 см в отделке Materico Cannella C970.

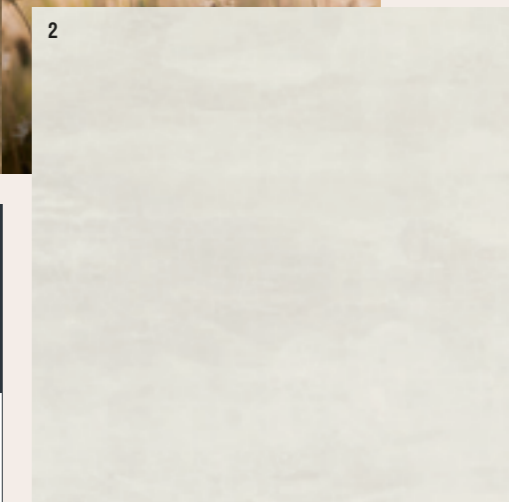
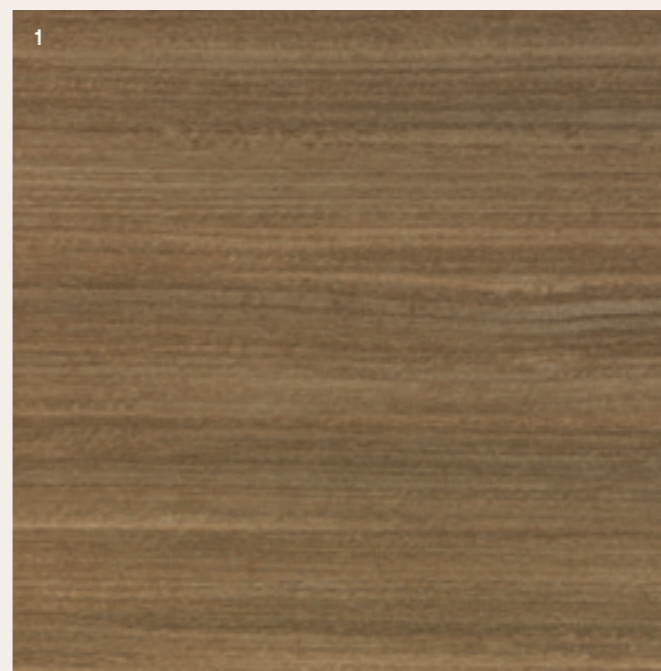

MATERIALI MATERIALS

1. MATERICO CANNELLA C970
2. MATERICO TALCO C900
3. LACCATO OPACO ARDESIA C06
4. TECNORIL® BIANCO



SPECCHIERA MIRRORS

CORNER con lampada led VELETTA.
CORNER mirror with VELETTA led lamp.

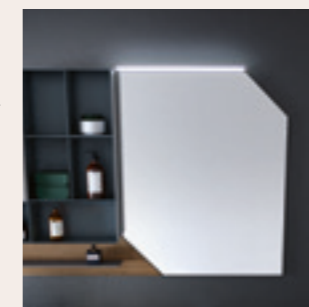

LAVABO WASHBASIN

Top sp. 1,2 cm Tecnoril® Bianco con vasca Scivolo.
Top sp. 1,2 cm Tecnoril® Bianco with Scivolo bowl.

SUPERFICI ALTAMENTE PRESTANTI

L'AMPIO PIANO DI
APPOGGIO E I FRONTALI
DEI CAPIENTI CASSETTI
VALORIZZANO LA
FINITURA MATERICA
EFFETTO LEGNO,
APPOSITAMENTE
STUDIATA PER IL
BAGNO: RESISTENTE E
DURATURA.

DASHING SURFACES. THE LARGE TOP AND
FRONTS OF THE CAPACIOUS DRAWERS ENHANCE
THE TEXTURED FINISH OF THE WOOD EFFECT.
RESISTANT AND DURABLE, SPECIALLY DESIGNED
FOR BATHROOMS.

THAI **316**

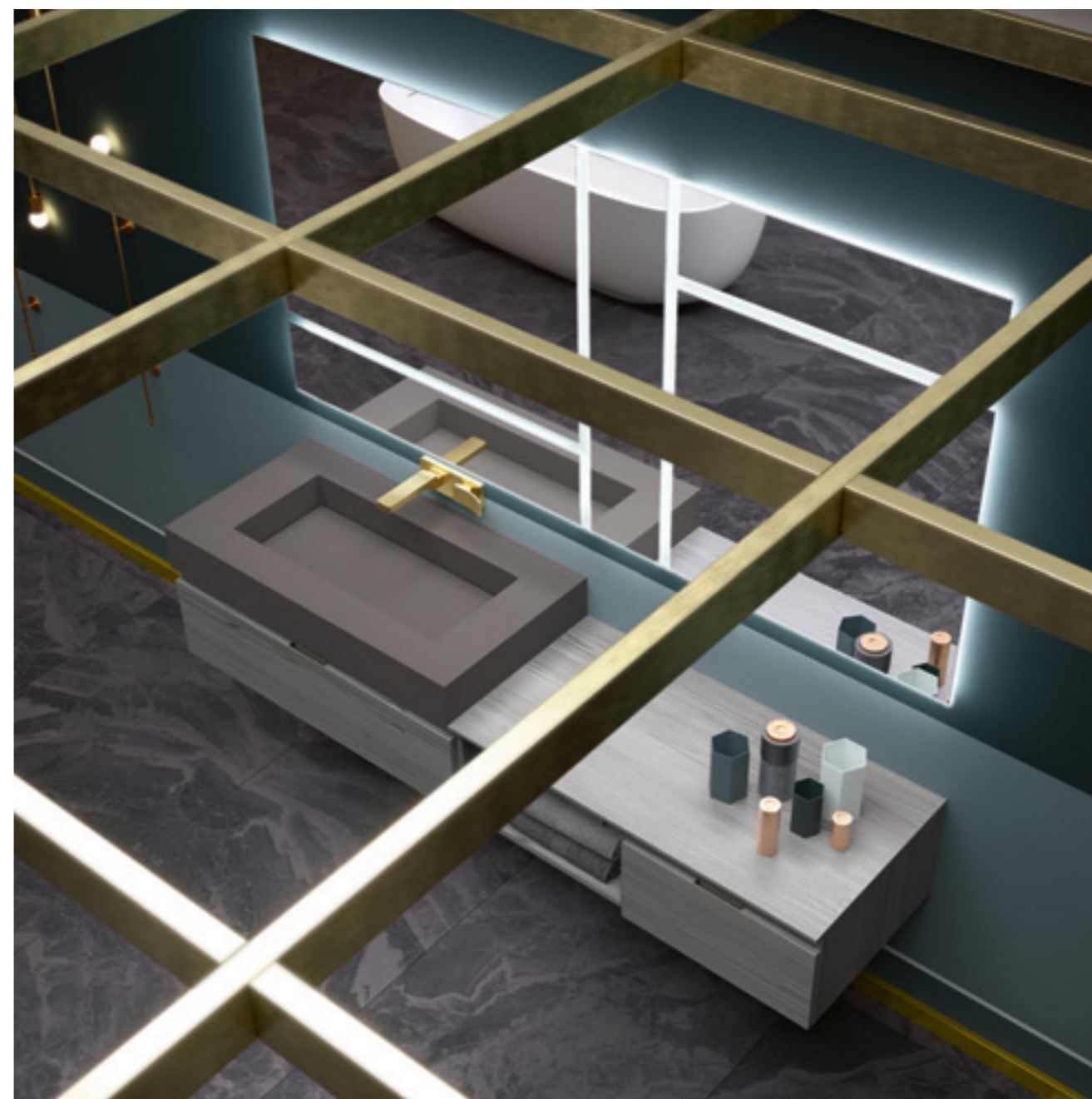

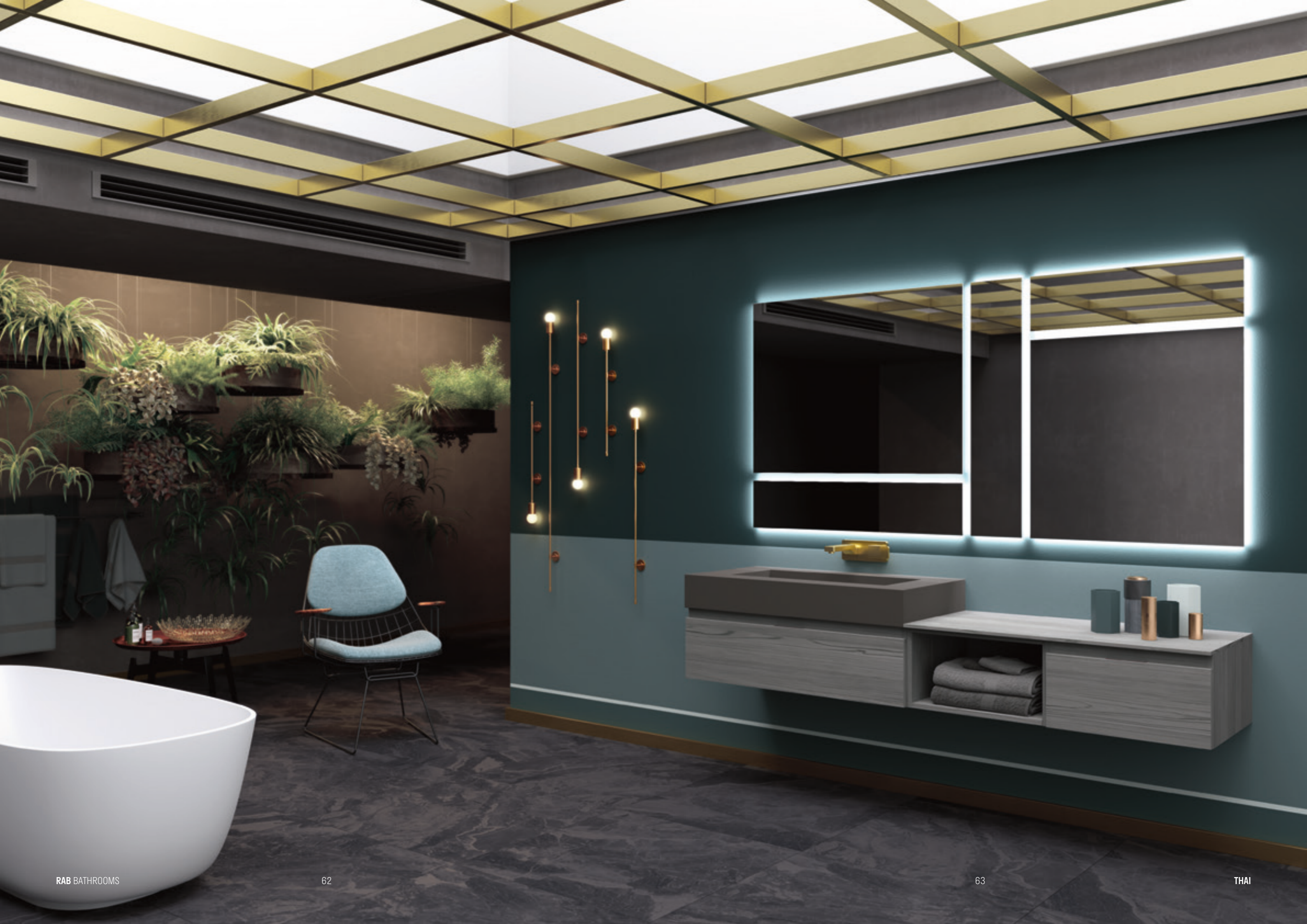



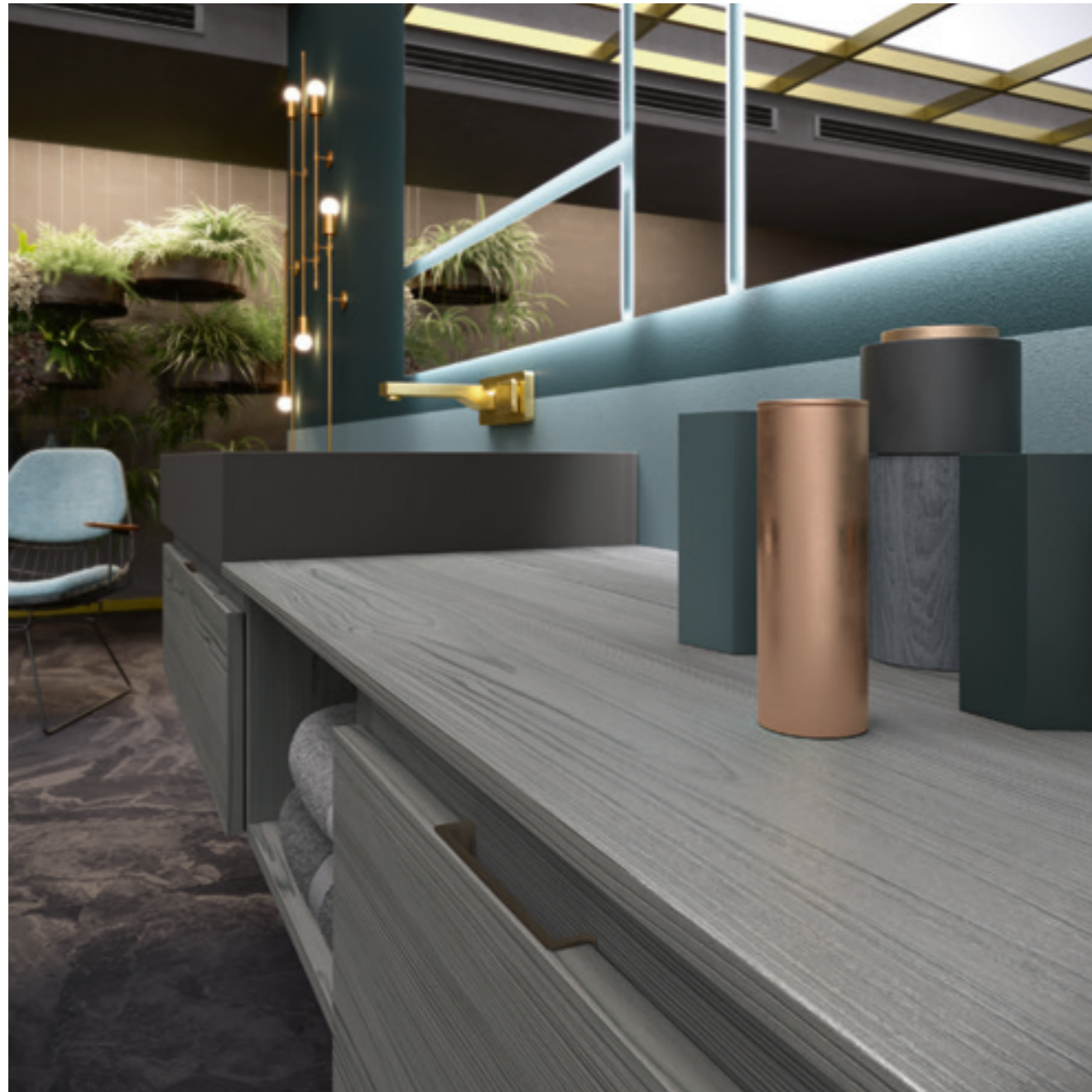

THAI 316

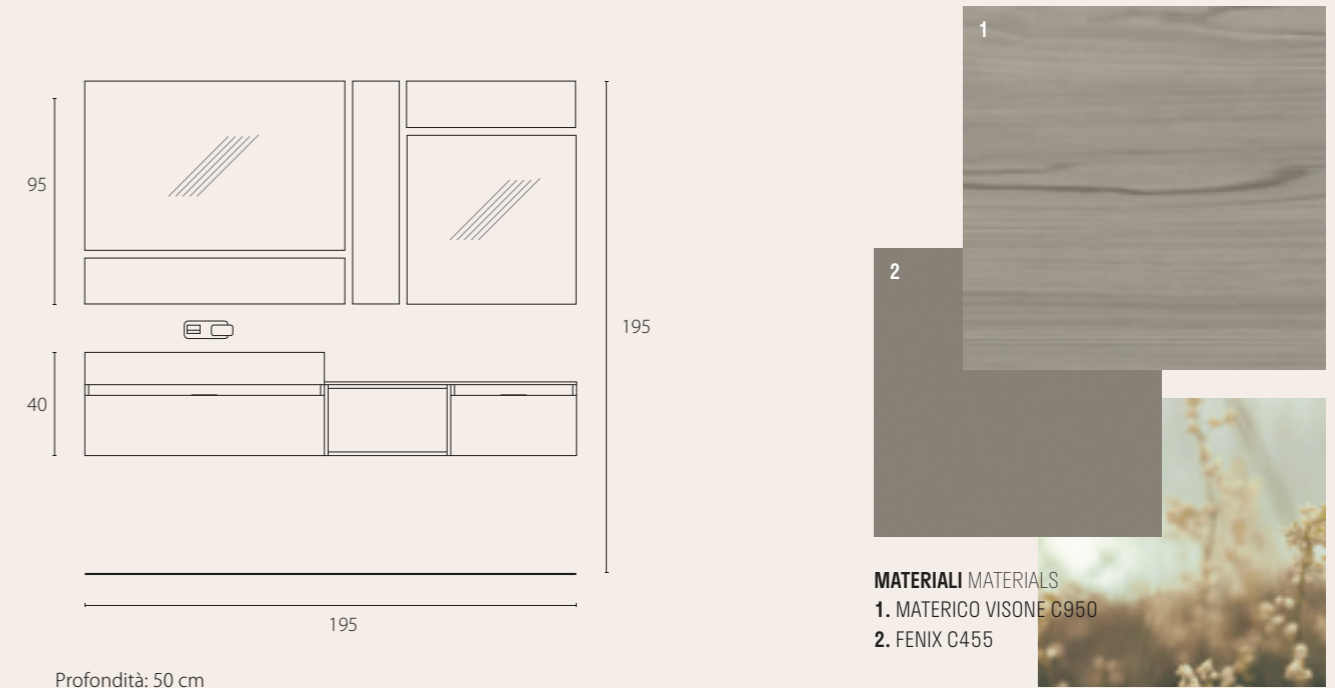

DESCRIZIONE DESCRIPTION

Top H 12 cm Fenix C455 con vasca VF070.
Basi e vano a giorno in Materico Visone C950,
 apertura presa diretta.
 Specchiere senza profili retroilluminati.

EN. H 12cm Top Fenix C455 with bowl VF070. Base
 units and open compartment in Materico Visone C950,
 grip opening. Mirrors without back lit profiles.

FR. Plan H 12 cm Fenix C455 avec cuve VF070.
 Eléments bas et compartiment ouvert en Materico
 Visone C950, ouverture prise directe. Miroirs sans
 profils rétroéclairés

ES. Encimera H 12 cm Fenix C455 con pila VF070.
 Muebles bajos y compartimento abierto de Materico
 Visone C950, apertura presa directa. Espejos sin
 perfiles retroiluminados

DE. Waschtischplatte H 12 cm Fenix C455 mit
 Waschbecken VF070. Unterschränke und offenes
 Fach in Materico Visone C950, mit Griffmulde.
 Hinterleuchtete Spiegel ohne Profile.

RU. Столешница В. 12 см Fenix C455 с раковиной
 VF070. Нижние шкафы и открытое отделение в
 отделке Materico Visone C950, встроенная в верх
 фасада ручка. Зеркала без профиля с подсветкой с
 обратной стороны.

RAFFINATI DETTAGLI
IN OTTONE LACCATO E
SPAZZOLATO

SONO LA GOLA E LA
 CORNICE IN METALLO
 DELLO SPECCHIO AD
 IMPREZIOSIRE I TONI
 CHIARI E DELICATI.
 LO SPESSORE DEL TOP
 IN MATERICO TALCO DÀ
 ULTERIORE CONSISTENZA
 AL TUTTO.

REFINED BRASS, LACQUERED AND BRUSHED
 DETAILS. THE LIGHT, DELICATE COLOURS ARE
 ENHANCED BY THE GRIP PROFILE AND METAL
 FRAME OF THE MIRROR. THE THICK TOP IN
 MATERICO TALCO GIVES STRENGTH TO THE
 ENTIRE COMPOSITION.

THAI **317**







THAI 317

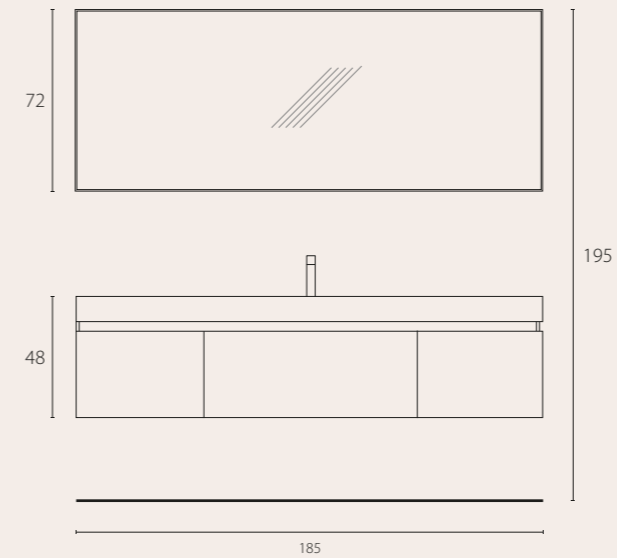

Profondità: 50 cm



MATERIALI MATERIALS
1. MATERICO TALCO C900
2. LACCATO OPACO BIANCO C01

DESCRIZIONE DESCRIPTION

Top H 10 cm in Materico Talco C900.
 Basi in laccato opaco Bianco C01, gola Ottone.
 Specchiera Jolly con cornice perimetrale in ottone spazzolato e luce a led integrata.

EN. H 10 cm Top in Materico Talco C900. Base unit in matt lacquered Bianco C01, Ottone grip profile. Jolly mirror with brass perimetral frame and inset led light.

FR. Plan H 10 cm en Materico Talco C900. Élément bas en laqué mat Bianco C01, gorge en Ottone. Miroir Jolly avec cadre périmétrique en laiton et lumière à led intégrée.

ES. Encimera H 10 cm de Materico Talco C900. Mueble bajo de lacado mate Bianco C01, perfil rebajado de Ottone. Espejo Jolly con marco perimetral de latón y luz led integrada.

DE. Waschtischplatte H 10 cm in Materico Talco C900. Unterschrank in Lack Matt Bianco C01, Hohlkehle aus Messing. Spiegel Jolly mit umlaufendem Rahmen aus Messing und eingebauter LED-Beleuchtung.

RU. Столешница В. 10 см в отделке Materico Talco C900. Нижний шкаф в матовой лакировке Bianco C01, ручка-углубление Ottone. Зеркало Jolly с рамой Ottone и встроенная светодиодная подсветка.

I nuovi Lavabi in appoggio scelti per Thai, hanno forme sinuose e spigoli arrotondati. La finitura satinata è disponibile nelle cinque nuove colorazioni effetto matt. Per chi ama le forme squadrate è proposta la versione soprapiano rettangolare.

The new sit-on wash basins chosen for Thai are sinuous with rounded edges. The brushed finish comes in five new matt colours. There is a rectangular counter top version for those who prefer square shapes.

Les nouveaux lavabos d'appui choisis par Thai ont des formes sinueuses et des arêtes arrondies. La finition satinée, disponible dans les cinq nouvelles colorations effet mat. Pour ceux qui aiment les formes carrées, proposée dans la version sur plan rectangulaire.

Los nuevos Lavabos de apoyo elegidos para Thai, tienen líneas sinuosas y cantos redondeados. El acabado satinado, disponible en los cinco nuevos colores efecto matt. Para quien ama las formas cuadradas, se propone la versión sobre la encimera rectangular.

Die neuen Aufsatzwaschbecken von Thai haben geschwungene Formen und abgerundete Kanten. Die satinierete Ausführung ist in den fünf neuen Farben in matter Optik erhältlich. Für Liebhaber von eckigen Formen.

Новые надставные раковины изысканных закругленных очертаний для коллекции Thai. Сатинированная отделка в пяти новых цветах с матовым эффектом. Предлагаем также прямоугольные раковины тем, кто не любит округленные формы.

LAVABI THAI new

LAVABI IN MINERALUX LISCIO / WASHBASINS IN MINERALUX LISCIO

BIANCO LUCIDO +

COLORI OPACHI

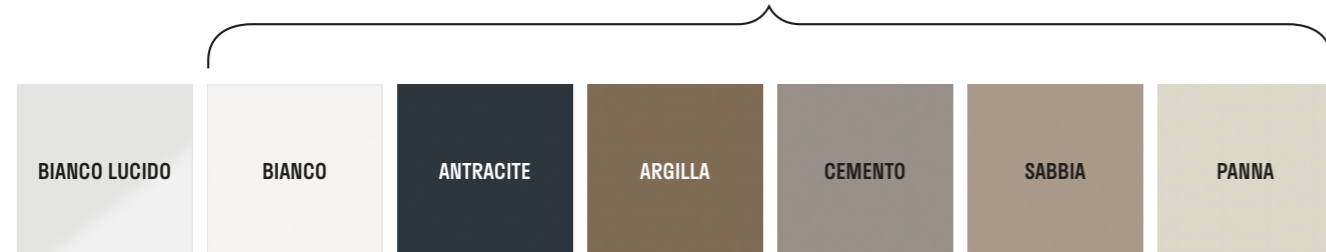

NICOLE Lavabo appoggio / raised washbasin
LC901

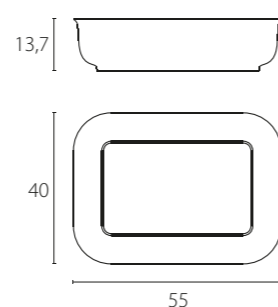

JOY Lavabo appoggio / raised washbasin
LC902

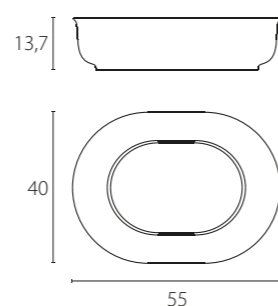

LEO Lavabo appoggio / raised washbasin
LC903

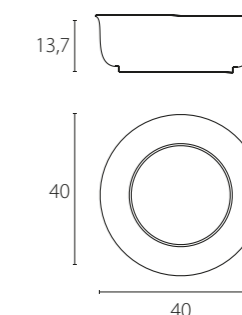

JESSICA Lavabo appoggio / raised washbasin
LC904

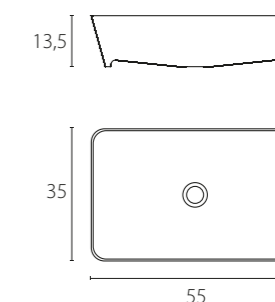

BOTERO Lavabo appoggio / raised washbasin
LC905

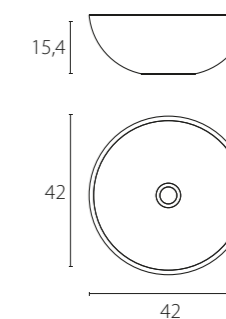

ELISA Lavabo soprapiano / raised washbasin
LC420

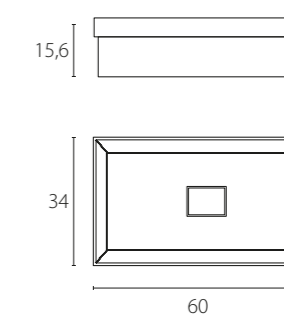

FORTI SPESSORI PER I PIANI SOVRAPPOSTI

UNA SOLUZIONE FORMALE
E COMPOSITIVA INEDITA
PER UNO SPAZIO BAGNO
FUNZIONALE CHE NON SI
FA MANCARE NULLA.

EXTRA THICK OVERLAPPING TOPS. A FORMAL
SOLUTION FOR UNUSUAL, FUNCTIONAL
BATHROOM COMPOSITIONS THAT LACK NOTHING.

THAI **318**











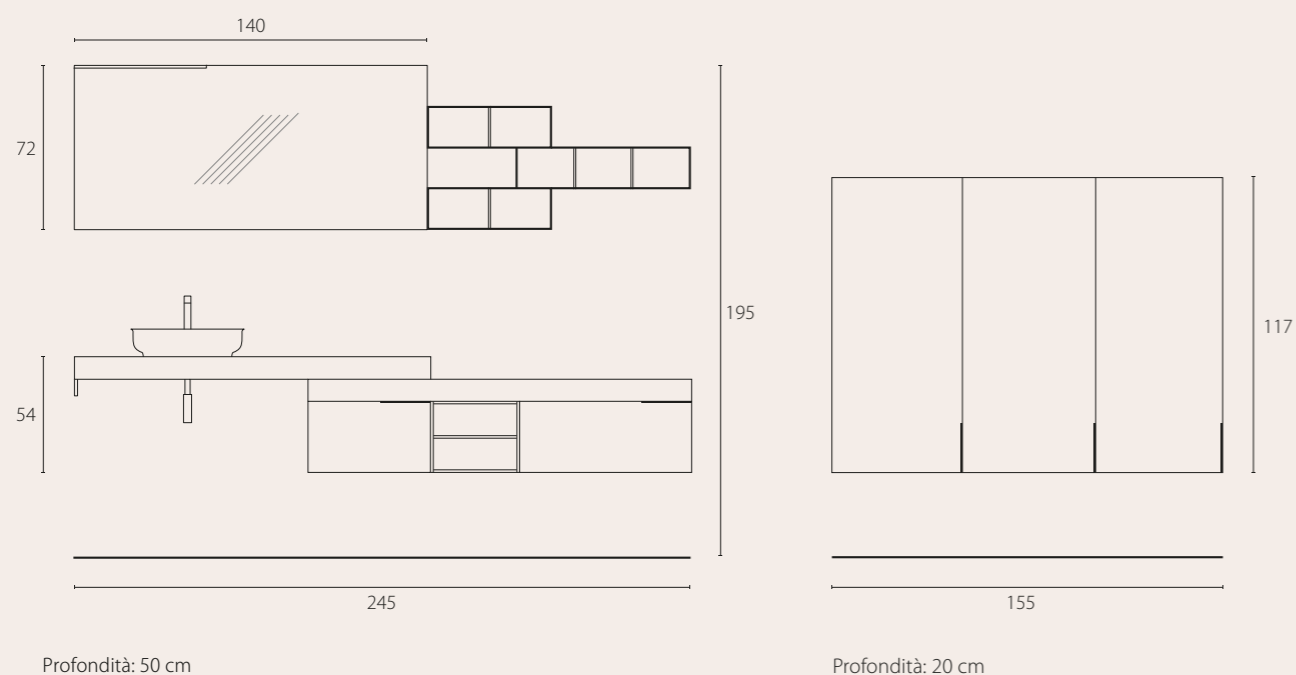

Profondità: 50 cm

Profondità: 20 cm

DESCRIZIONE DESCRIPTION

Top H10 in Materico Vulcano C920, lavabo Nicole in Mineralux Bianco. Porta salviette in metallo laccato opaco Nero C82.

Basi con top folding in Materico Carbone C960, Maniglie in metallo Nero. Base a giorno in laccato opaco Creta C19. Elementi pensili a giorno in metallo laccato opaco Creta C19. Specchiera con profili nero spazzolato e lampada led Veletta.

Pensili in Materico Carbone C960, Maniglie in metallo Nero.

EN. Top H10 in Materico Vulcano C920, Nicole washbasin in Mineralux Bianco. Towel rail in Matt lacquered metal Nero C82. Base units with folding top in Materico Carbone C960, Black metal handles. Open base unit in Matt lacquered Creta C19. Open wall units in matt lacquered metal Creta C19. Mirror with brushed black profiles and Veletta led lamp. Wall units in Materico Carbone C960, Handles in Black metal.

FR. Plan H10 en Materico Vulcano C920, lavabo Nicole en Mineralux Bianco. Porte-serviettes en métal laqué mat Nero C82. Éléments bas avec plan folding en Materico Carbone C960, Poignées en métal Noir. Éléments bas ouverts en laqué mat Creta C19. Éléments hauts ouverts en métal laqué mat Creta C19. Miroir avec profils noir brossé et lampe led Veletta. Éléments hauts en Materico Carbone C960, Poignées en métal Noir.

ES. Encimera H10 de Materico Vulcano C920, lavabo Nicole de Mineralux Bianco. Toallero de metal lacado mate Nero C82. Muebles bajos con encimera folding de Materico Carbone C960, Tiradores de metal negro. Mueble bajo abierto de lacado mate Creta C19. Elementos colgantes abiertos de metal lacado mate Creta C19. Espejo con perfiles negro cepillado y lámpara led Veletta. Muebles colgantes de Materico Carbone C960, Tiradores de metal Negro.

DE. Waschtischplatte H10 in Materico Vulcano C920, Waschbecken Nicole aus Mineralux Bianco. Handtuchhalter aus matt lackiertem Metall in Nero C82. Unterschranke mit Folding-Platte in Materico Carbone C960, Griffe aus schwarzem Metall. Offener Unterschrank in Lack Matt Creta C19. Offene Hängeelemente aus matt lackiertem Metall in Creta C19. Spiegel mit gebürsteten schwarzen Profilen und LED-Lampe Veletta. Hängeschränke in Materico Carbone C960, Griffe aus schwarzem Metall.

RU. Столешница B.10 в отделке Materico Vulcano C920. Раковина Nicole из Mineralux Bianco. Держатель для полотенец из металла в матовой лакировке Nero C82. Нижние шкафы со столешницей folding в отделке Materico Carbone C960. Черные металлические ручки. Открытое отделение в матовой лакировке Creta C19. Открытые навесные элементы из металла в матовой лакировке Creta C19. Зеркало с черным брашированным профилем и светодиодным светильником Veletta. Навесные шкафы в отделке Materico Carbone C960. Черные металлические ручки.



MATERIALI MATERIALS

1. MATERICO CARBONE C960
2. MATERICO VULCANO C920
3. LACCATO OPACO CRETA C19

SPECCHIERA MIRRORS

Specchiera con profili nero spazzolato e lampada led Veletta. Mirror with brushed black profiles and Veletta led lamp.

LAVABO WASHBASIN

Lavabo Nicole in Mineralux Bianco. Nicole washbasin in Mineralux Bianco.



L'UNITÀ TRA LE DIFFERENZE

GLI ESSENZIALI
ELEMENTI ESALTANO
LE SUPERFICI: EFFETTO
MARMO LUCIDO PER IL
PIANO E LA SCHIENA IN
CONTRAPPOSIZIONE ALLA
POROSITÀ DELLE BASI IN
MATERICO TALCO.

UNISON AMONG DIFFERENCES. ESSENTIAL
ELEMENTS EXALT THE SURFACES: A GLOSSY
MARBLE EFFECT FOR THE BACK PANEL
CONTRASTS WITH THE POROUS MATERICO TALCO
WASH BASIN.

THAI **319**











THAI 319

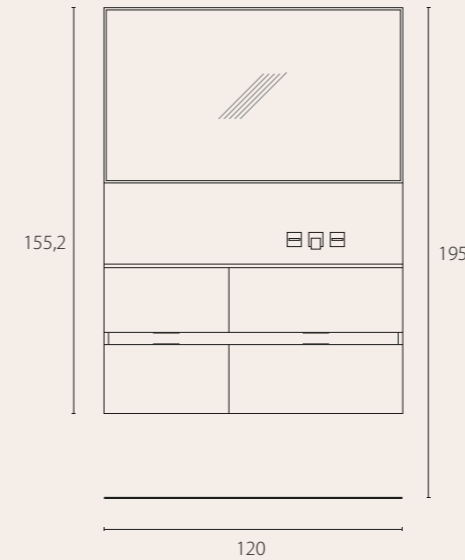

Profondità: 50 cm



MATERIALI MATERIALS
1. MATERICO TALCO C900
2. LAMINAM NERO GRECO LUCIDATO

DESCRIZIONE DESCRIPTION

Top sp. 1,2 cm Laminam Nero Greco Lucidato con vasca LA100 e alzatina H 30 cm.
Base in Materico Talco C900, apertura presa diretta.
Specchiera Jolly con cornice in alluminio nero spazzolato.

EN. Top th. 1,2 cm in Laminam Nero Greco Lucidato with bowl LA100 and upstand H 30 cm. Base unit in Materico Talco C900, apertura presa diretta.
Jolly Mirror with frame in brushed black aluminium.

FR. Plan ép. 1,2 cm en Laminam Nero Greco Lucidato avec cuve LA100 et rehausse H 30 cm. Élément bas en Materico Talco C900, ouverture prise directe. Miroir Jolly avec cadre en aluminium noir brossé.

ES. Encimera esp. 1,2 cm de Laminam Nero Greco Lucidato con pila LA100 y copete H 30 cm. Mueble bajo de Materico Talco C900, apertura presa directa.
Espejo Jolly con marco de aluminio negro cepillado.

DE. Waschtischplatte St. 1,2 cm mit Waschbecken aus Laminam in Griechisch Schwarz Hochglanz mit Waschbecken LA100 und Wandplatte H 30 cm.
Unterschrank in Materico Talco C900, mit Griffmulde.
Spiegel Jolly mit Rahmen aus gebürstetem schwarzem Aluminium.

RU. Столешница толщиной 1,2 см из Laminam Nero Greco Lucidato с раковиной LA100 и бортиком В. 30 см. Нижние шкафы в отделке Materico Talco C900, встроенная ручка. Зеркало Jolly с рамой из брашированного черного алюминия.

**IL DESIGN È
INNOVATIVO NELLA
DEFINIZIONE DEI
DETTAGLI**

LA PANCA IN METALLO
NERO SU CUI POGGIA
LA BASE RAFFORZA
L'ESTETICA GENERALE E
SI ACCOMPAGNA ALLE
SOTTILI MANIGLIE.

INNOVATIVE DESIGN DEFINES DETAILS. THE
BLACK METAL BENCH SUPPORTING THE BASE
UNIT ENHANCES AESTHETICS AND MATCHES WITH
THE HANDLE.

THAI **320**









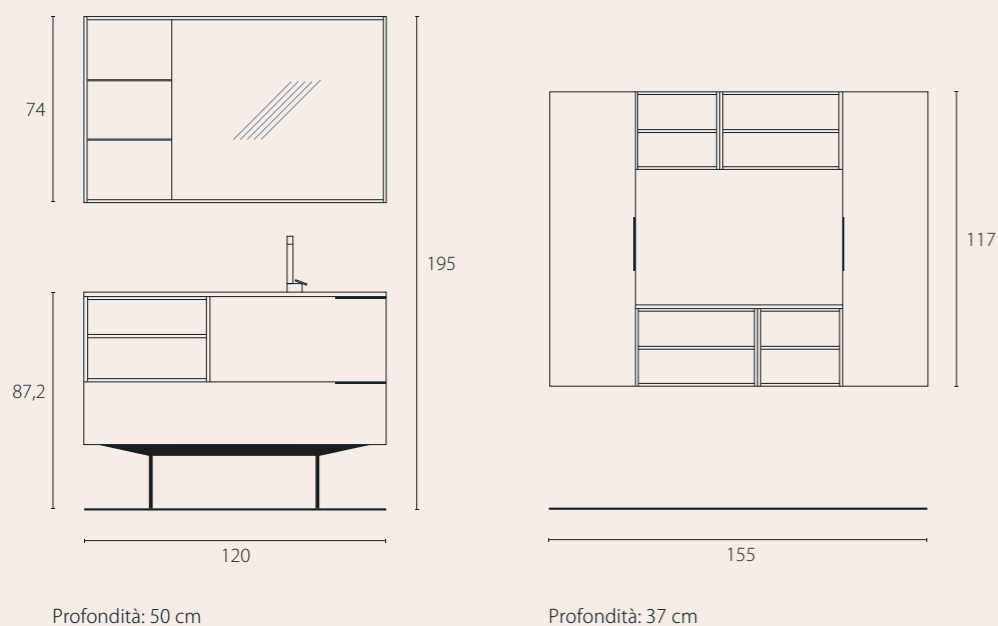

Profondità: 50 cm

Profondità: 37 cm

DESCRIZIONE DESCRIPTION

Top sp. 1,2 cm in Laminam Orobico Grigio Lucidato con vasca LA100.

Base in Materico Visone C950 su panca in metallo nero, Maniglie in metallo Titanio. Base a giorno in laccato opaco Cemento C04.

Specchiera Square Plus in laccato opaco Cemento C04. Colonne incassate a muro in Materico Visone C950 con elementi a giorno in laccato opaco Cemento C04. Piatto doccia Flatsystem in Mineralux Cemento.

EN. Top th. 1,2 cm in Laminam Orobico Grigio Lucidato with bowl LA100. Base unit in Materico Visone C950 on bench in Black metal, Handles in Titanio metal. Open base unit in matt lacquered Cemento C04. Square Plus mirror in matt lacquered Cemento C04. Built-in tall units in Materico Visone C950 with open elements in matt lacquered Cemento C04. Flatsystem shower tray in Mineralux Cemento.

FR. Plan ép. 1,2 cm en Laminam Orobico Grigio Lucidato avec cuve LA100. Élément bas en Materico Visone C950 sur banc en métal noir, Poignées en métal Titanio. Élément bas ouvert en laqué mat Cemento C04. Miroir Square Plus en laqué mat Cemento C04. Colonnes encastrées au mur en Materico Visone C950 avec éléments ouverts en laqué mat Cemento C04. Bac de douche Flatsystem en Mineralux Cemento.

ES. Encimera esp. 1,2 cm de Laminam Orobico Grigio Lucidato con pila LA100. Muebel bajo de Materico Visone C950 en el banco de metal negro, Tiradores de metal Titanio. Mueble bajo abierto de lacado mate Cemento C04. Espejo Square Plus de lacado mate Cemento C04. Columnas empotradas en la pared de Materico Visone C950 con elementos abiertos de lacado mate Cemento C04. Plato de ducha Flatsystem de Mineralux Cemento.

DE. Waschtischplatte St. 1,2 cm in Laminam Orobico Grau Hochglanz mit Waschbecken LA100. Unterschrank in Materico Visone C950 auf Gestell aus schwarzem Metall, Griffe aus gebürstetem Metall Titan. Offener Unterschrank in Lack Matt Cemento C04. Spiegel Square Plus in Lack Matt Cemento C04. Hochschränke für Wandeinbau in Materico Visone C950 mit offenen Elementen in Lack Matt Zement C04. Duschwanne Flatsystem aus Mineralux Zement.

RU. Столешница толщиной 1,2 см из Laminam Orobico Grigio Lucidato с раковиной LA100. Нижний шкаф в отделке Materico Visone C950 на ножках из черного металла. Ручки из брашированного металла Titanio. Открытое отделение в матовой лакировке Cemento C04. Зеркало Square Plus в матовой лакировке Cemento C04. Высокие шкафы в отделке Materico Visone C950 с открытыми отделениями в матовой лакировке Cemento C04. Душевой поддон Flatsystem из Mineralux Cemento.

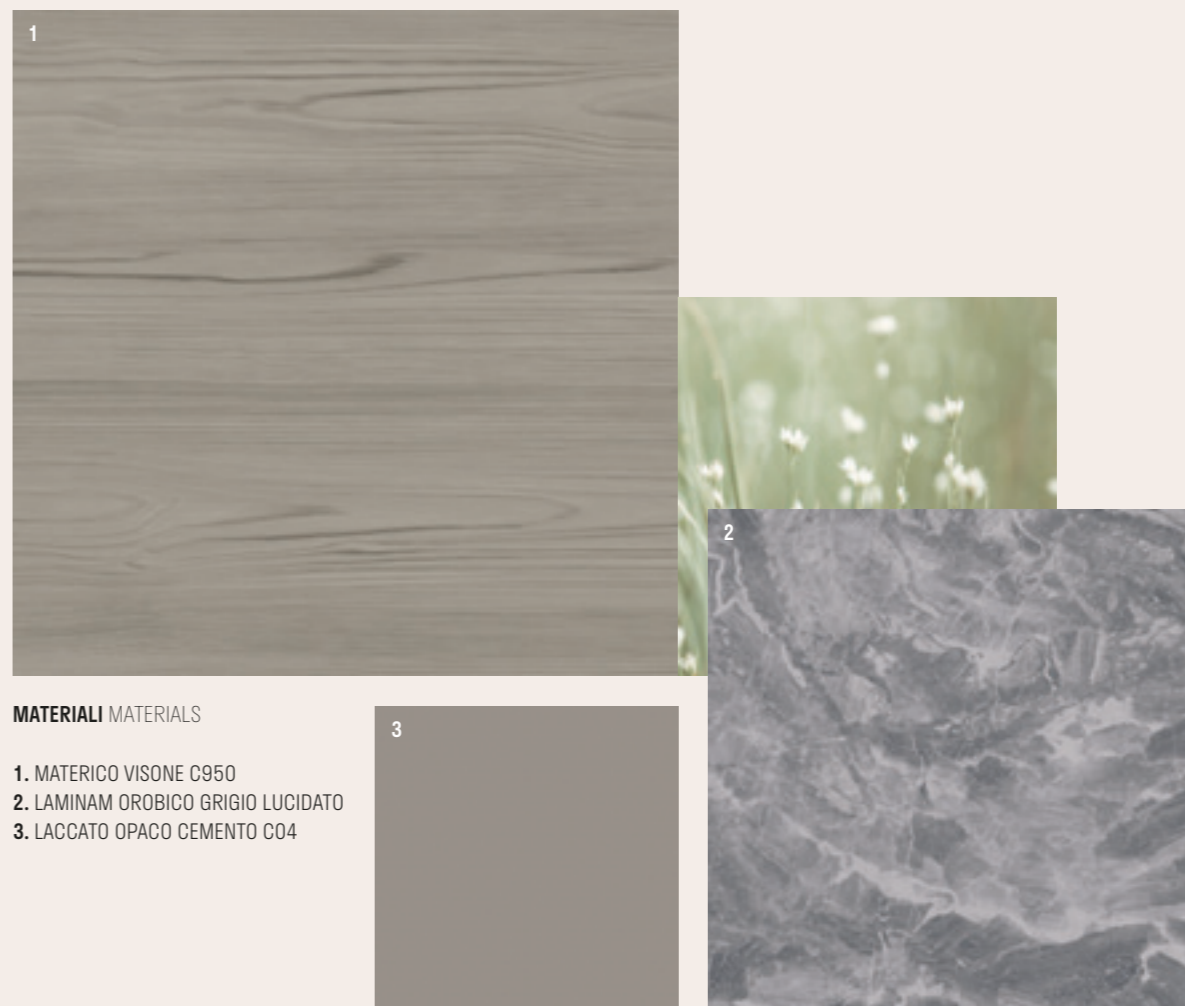

MATERIALI MATERIALS

1. MATERICO VISONE C950
2. LAMINAM OROBICO GRIGIO LUCIDATO
3. LACCATO OPACO CEMENTO C04

SPECCHIO MIRRORS

Specchiera SQUARE PLUS laccato opaco Cemento C04. SQUARE PLUS mirror in matt lacquered Cemento C04

LAVABO WASHBASIN

Top sp. 1,2 cm in Laminam Orobico Grigio Lucidato con vasca LA100. Top th. 1,2 cm in Laminam Orobico Grigio Lucidato with bowl LA100.

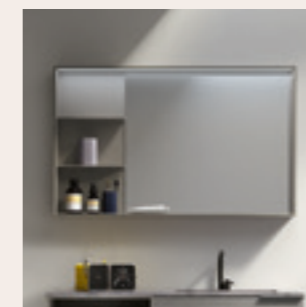

UN CONCETTO DI LEGGEREZZA

MODULI SOSPESI
SI DISPONGONO
INDIPENDENTI SULLA
PARETE CREANDO UN
INSIEME EQUILIBRATO
ED ACCOGLIENTE.

THE CONCEPT OF AIRINESS. SUSPENDED
MODULES SEPARATELY ARRAYED ON THE
WALL CREATE A WELL-BALANCED, COSY
ATMOSPHERE.

THAI **321**





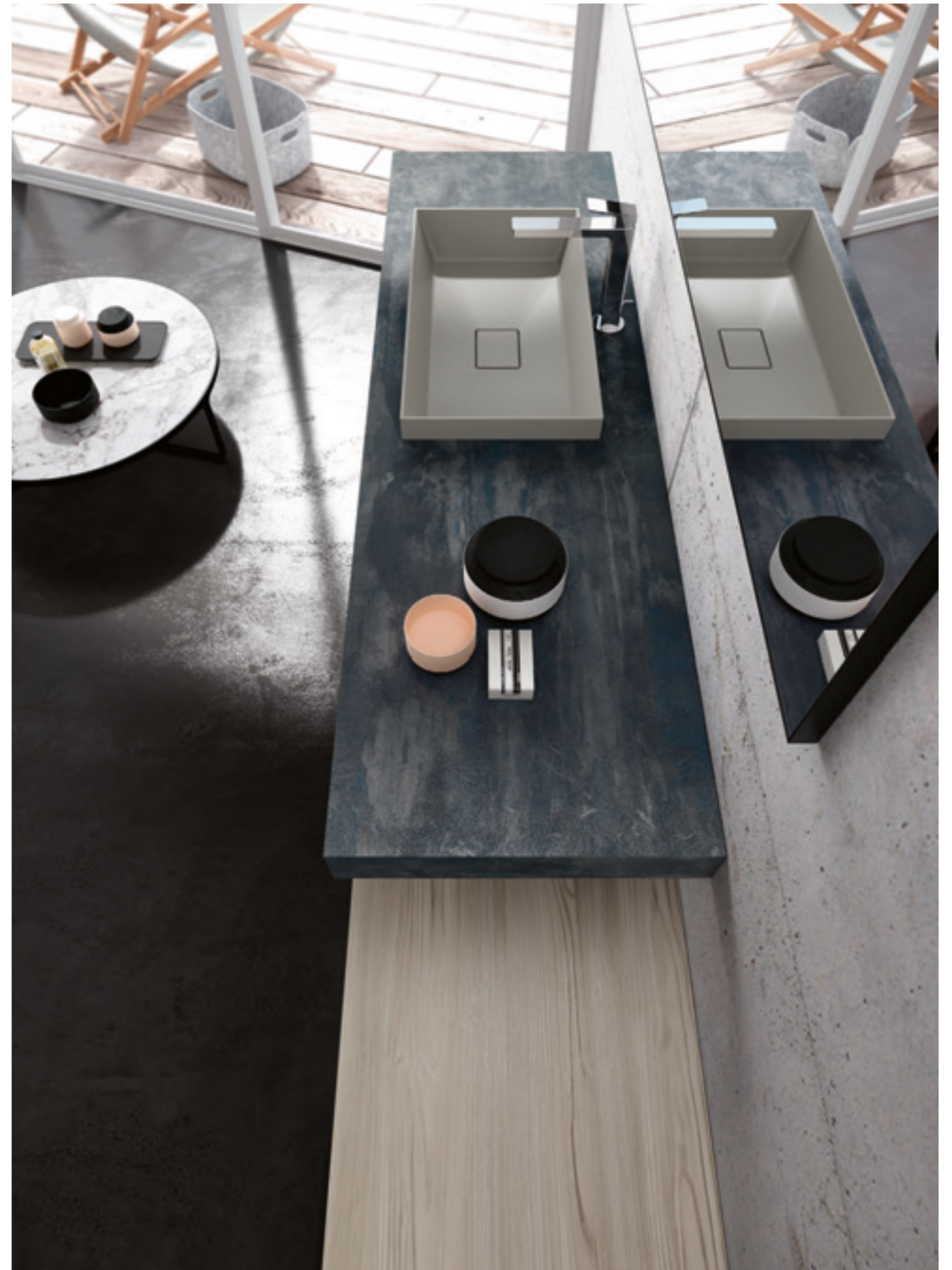

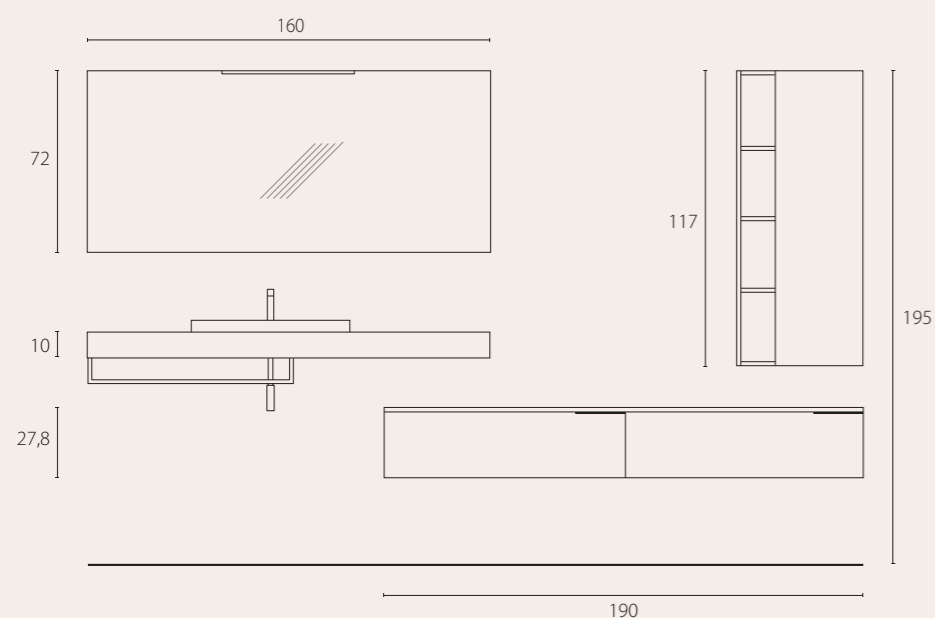

Profondità: 50/20 cm

DESCRIZIONE DESCRIPTION

Top H 10 cm in Materico Basalto C930, lavabo Elisa in Mineralux Cemento.

Porta salviette in metallo laccato opaco Nero C82.

Basi con top sp. 1,8 cm in Materico Lino C940, Maniglie in metallo Nero.

Pensile in Materico Lino C940, schiena a vista in laccato opaco Nero C82.

Specchiera con profili nero spazzolato e lampada led Veletta.

EN. Top H 10 cm in Materico Basalto C930, Elisa washbasin in Mineralux Cemento. Towel rail in matt lacquered metal Nero C82. Base units with th. 1.8 cm top in Materico Lino C940, Handles in brushed black metal. Wall unit in Materico Lino C940, visible back panel in Matt lacquered Nero C82. Mirror with brushed black profiles and Veletta led lamp.

FR. Plan H 10 cm en Materico Basalto C930, lavabo Elisa en Mineralux Cemento. Porte-serviettes en métal laqué mat Nero C82. Éléments bas avec plan ép. 1,8 cm en Materico Lino C940, Poignées en métal Noir. Élément haut en Materico Lino C940, dos visible en laqué mat Nero C82. Miroir avec profils noir brossé et lampe led Velett.

ES. Encimera H 10 cm de Materico Basalto C930, lavabo Elisa de Mineralux Cemento. Toallero de metal lacado mate Nero C82. Muebels bajos con encimera esp. 1,8 cm de Materico Lino C940, Tiradores de metal Negro. Muebel colgante de Materico Lino C940, trasera visible de lacado mate Nero C82. Espejo con perfiles negro cepillado y lámpara led Veletta.

DE. Waschtischplatte H 10 cm in Materico Basalto C930, Waschbecken Elisa aus Mineralux Cemento. Handtuchhalter aus matt lackiertem Metall in Nero C82. Unterschränke mit Deckplatte St. 1,8 cm in Materico Lino C940, Griffe aus schwarzem Metall. Hängeschrank in Materico Lino C940, Sichtrückwand in Lack Matt Nero C82. Spiegel mit gebürsteten schwarzen Profilen und LED-Lampe Veletta.

RU. Столешница В. 10 см в отделке Materico Basalto C930, раковина Elisa из Mineralux Cemento. Держатель для полотенец из металла в матовой лакировке Nero C82. Нижние шкафы со столешницей толщиной 1,8 см в отделке Materico Lino C940. Черные металлические ручки. Навесные шкафы в отделке Materico Lino C940, задняя панель в матовой лакировке Nero C82. Зеркало с брашированными профилями и светодиодным светильником Veletta.

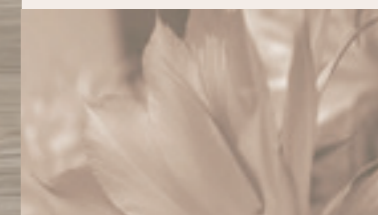

MATERIALI MATERIALS

1. MATERICO LINO C940
2. MATERICO BASALTO C930
3. MINERLUX CEMENTO



SPECCHIO MIRRORS

Specchiera con profili nero spazzolato e lampada led VELETTA. Mirror with brushed black profiles and Veletta led lamp.



LAVABO WASHBASIN

Lavabo ELISA in Mineralux Cemento. ELISA washbasin in Mineralux Cemento.

PERSONALIZZAZIONE **SUGGESTIVA**

L'AUTENTICITÀ STA NEL
COLORE E NEI MATERIALI
DI ALTISSIMA QUALITÀ
OLTRE CHE NELLA
DISPOSIZIONE CREATIVA
DEGLI ELEMENTI.

ATTRACTIVE CUSTOMISATION. AUTHENTICITY
IS PROVIDED BY COLOURS AND TOP QUALITY
MATERIALS AS WELL AS THE CREATIVE LAYOUT
OF THE ELEMENTS.

THAI **322**









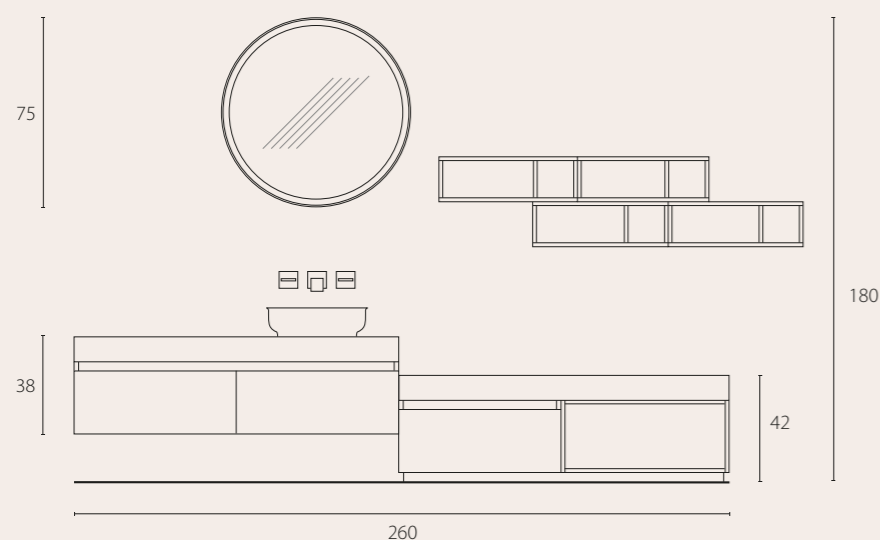

Profondità: 50 cm

DESCRIZIONE DESCRIPTION

Top H 10 cm in Materico Pepe C980. Lavabo Leo in Mineralux Cemento.
Basi in Materico Pepe C980 con gola Titanio e zoccolo laccato opaco Ardesia C06.
Pensili a giorno laccato opaco Anice C87 e laccato opaco Cemento C04.
Specchiera Metal con cornice in metallo laccato opaco Cemento C04.
Panca in metallo nero con top in Materico Pepe C980.
Pensili in laccato opaco Cemento C04, Maniglia Titanio, elementi a giorno in laccato opaco Anice C87.

EN. Top H 10 cm in Materico Pepe C980. Leo washbasin in Mineralux Cemento. Base units in Materico Pepe C980 with grip profiles Titanio and plinth in matt lacquered Ardesia C06. Open wall units in matt lacquered Anice C87 and matt lacquered Cemento C04. Metal mirror with frame in matt lacquered Cemento C04. Bench in black metal with top in Materico Pepe C980. Wall units in matt lacquered Cemento C04 with handle Titanio and open elements in matt lacquered Anice C87.

FR. Plan H 10 cm en Materico Pepe C980. Lavabo Leo en Mineralux Cemento. Éléments bas en Materico Pepe C980 avec gorges Titanio et socle laqué mat Ardesia C06. Éléments hauts ouverts laqué mat Anice C87 et laqué mat Cemento C04. Miroir Metal avec cadre en métal laqué mat Cemento C04. Banc en métal noir avec plan en Materico Pepe C980. Éléments hauts et laqué mat Cemento C04 avec poignée Titanio et éléments ouverts en laqué mat Anice C87.

ES. Encimera H 10 cm de Materico Pepe C980. Lavabo Leo de Mineralux Cemento. Muebles bajos de Materico Pepe C980 con perfiles rebajados Titanio y zócalo lacado mate Ardesia C06. Muebles colgantes abiertos lacado mate Anice C87 y lacado mate Cemento C04. Espejo Metal con marco de metal lacado mate Cemento C04. Banco de metal negro con encimera de Materico Pepe C980. Muebles colgantes de lacado mate Cemento C04 con tirador Titanio y elementos abiertos de lacado mate Anice C87.

DE. Waschtischplatte H 10 cm in Materico Pepe C980. Waschbecken Leo aus Mineralux Cemento. Unterschränke in Materico Pepe C980 mit Hohlkehlen Titanio und Sockel in Lack Matt Ardesia C06. Offene Hängeschränke in Lack Matt Anice C87 und Lack Matt Cemento C04. Spiegel Metal mit Rahmen aus matt lackiertem Metall in Cemento C04. Gestell aus schwarzem Metall mit Platte in Materico Pepe C980. Hängeschränke in Lack Matt Cemento C04 mit Griff Titan und offene Elemente in Lack Matt Anice C87.

RU. Столешница В. 10 см в отделке Materico Pepe C980. Раковина Leo из Mineralux Cemento. Нижние шкафы в отделке Materico Pepe C980 с ручкой-углублением Titanio и цоколем в матовой лакировке Ardesia C06. Навесные открытые отделения в матовой лакировке Anice C87 и Cemento C04. Зеркало Metal в раме из металла в матовой лакировке Cemento C04. Ножки из черного металла со столешницей в отделке Materico Pepe C980. Навесные шкафы в отделке Cemento C04 с ручкой Titanio и открытыми элементами в матовой лакировке Anice C87.

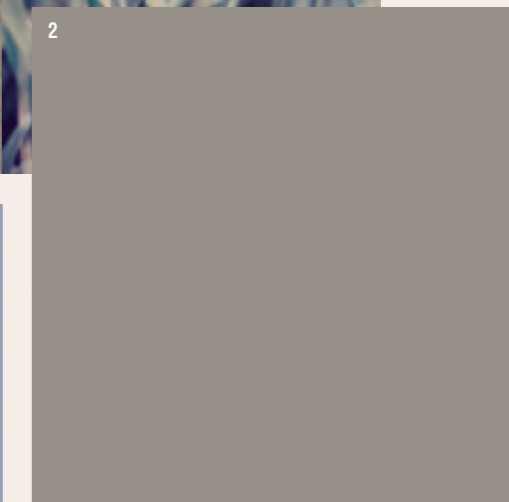
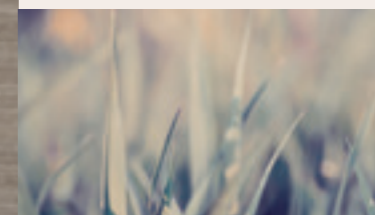

MATERIALI MATERIALS

- 1. MATERICO PEPE C980
- 2. LACCATO OPACO CEMENTO C04
- 3. LACCATO OPACO ANICE C87

SPECCHIO MIRRORS

Specchiera METAL con cornice in metallo laccato opaco Cemento C04.
METAL MIRROR with frame in matt lacquered metal Cemento C04.

LAVABO WASHBASIN

Lavabo LEO in Mineralux Cemento.
LEO washbasin in Mineralux Cemento.

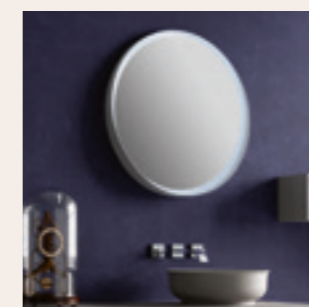

THAI È ANCHE CURVO

IL VOLUME È ADDOLCITO
DAI FRONTALI CURVI
CHE ASSECONDANO LE
ROTONDITÀ DEL CAPIENTE
LAVABO A FILO TOP.

THAI IS ALSO CURVES. VOLUME IS SOFTENED BY
CURVED FRONTS THAT ACCOMPANY THE CURVED
SHAPE OF THE LARGE WASHBASIN FLUSH WITH
THE TOP.

THAI **323**





THAI 323

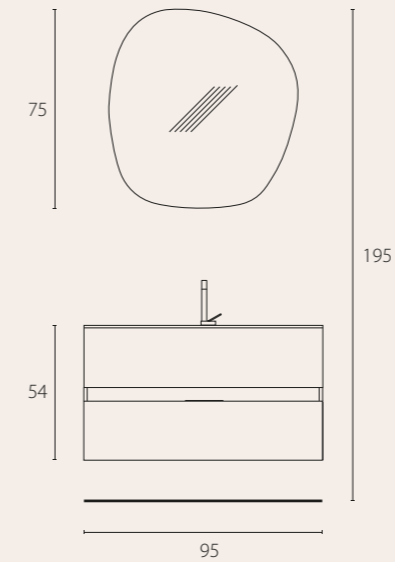

Profondità: 37/50 cm

1



MATERIALI MATERIALS
1. LACCATO OPACO CENERE C30

DESCRIZIONE DESCRIPTION

EN. Lavabo consolle Deni in Mineralux bianco lucido. Base curva in laccato opaco Cenere C30. Specchiera Sasso con lampada Gilda.

EN. Deni console washbasins in Mineralux bianco lucido. Curved base unit in matt lacquered Cenere C30. Sasso mirror with Gilda lamp.

FR. Lavabo consolle Deni en Mineralux blanc brillant. Élément bas courbé en laqué mat Cenere C30. Miroir Sasso avec lampe Gilda.

ES. Lavabo consola Deni de Mineralux blanco brillante. Mueble bajo curvo de lacado mate Cenere C30. Espejo Sasso con lámpara Gilda.

DE. Waschtisch mit Unterschrank Deni aus Mineralux Bianco Hochglanz. Gewölbter Unterschrank in Lack Matt Cenere C30. Spiegel Sasso mit Lampe Gilda.

RU. Литая раковина Deni из Mineralux bianco lucido. Изогнутый шкаф с матовой лакировкой Cenere C30. Зеркало Sasso со светильником Gilda.

LA SEMPLICITÀ
FORMALE NON
ESCLUDE MAI LA
BELLEZZA

UN MONOBLOCCO
COMPATTO E LINEARE,
ELEGANTE NELLA FORMA
E NELLE MORBIDE
FINITURE.

FORMAL SIMPLICITY NEVER FORGOES BEAUTY
A COMPACT, LINEAR MONOBLOC FEATURING
ELEGANT DESIGN AND SOFT FINISHES.

THAI **324**



THAI

**LA SPECCHIERA
SQUARE HA
MOLTEPLICI
FUNZIONI, INCLUDE
ALL'INTERNO DELLA
SUA CORNICE IN
METALLO MENSOLE E
LUCE A LED.**

THE SQUARE MIRROR IS
MULTI-FUNCTION,
INCORPORATING SHELVES AND
LED LIGHTS WITHIN ITS METAL
FRAME.

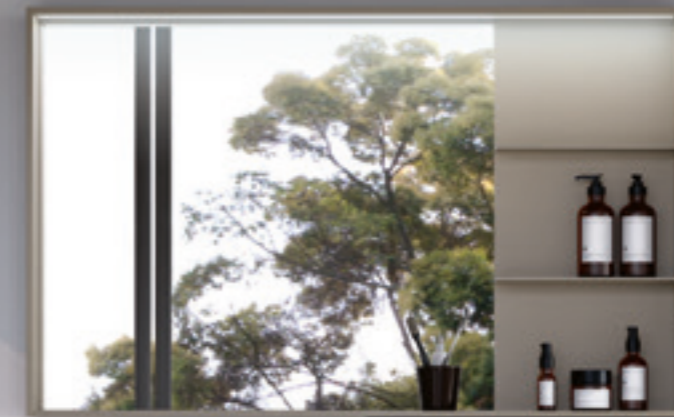



THAI 324

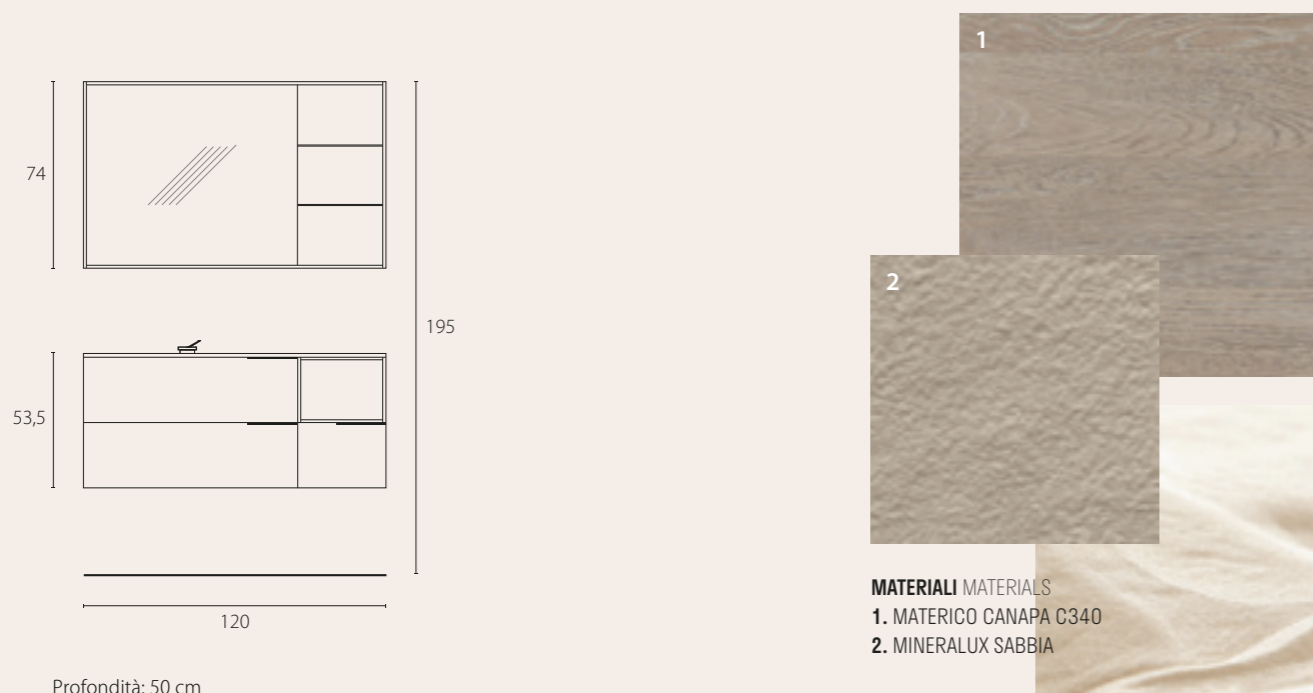

Profondità: 50 cm

DESCRIZIONE DESCRIPTION

Top sp. 1,5 cm in Mineralux Stone Sabbia con vasca Alfa.

Basi in Materico Canapa C340 con Maniglie in metallo Bronzo e vano a giorno in laccato opaco Sabbia C07.

Specchiera Square Plus in laccato opaco Sabbia C07.

EN. Top th. 1.5cm in Mineralux Stone Sabbia with Alfa bowl. Base units in Materico Canapa C340 with handles in Bronzo metal and open compartments in matt lacquered Sabbia C07. Square Plus mirror in matt lacquered Sabbia C07.

FR. Plan ép. 1,5 cm en Mineralux Stone Sabbia avec cuve Alfa. Eléments bas en Materico Canapa C340 avec poignées en métal Bronzo et compartiment ouvert en laqué mat Sabbia C07. Miroir Square Plus en laqué mat Sabbia C07.

ES. Encimera esp. 1,5 cm de Mineralux Stone Sabbia con pila Alfa. Muebles bajos de Materico Canapa C340 con tiradores de metal Bronzo y compartimento abierto de lacado mate Sabbia C07. Espejo Square Plus de lacado mate Sabbia C07.

DE. Waschtischplatte St. 1,5 cm aus Mineralux Stone Sand mit Waschbecken Alfa. Unterschränke in Materico Canapa C340 mit Griffen aus Metall Bronzo und offenes Fach in Lack Matt Sabbia C07. Spiegel Square Plus in Lack Matt Sabbia C07.

RU. Столешница толщиной 1,5 см из Mineralux Stone Sabbia с раковиной Alfa. Нижние шкафы в отделке Materico Canapa C340 с ручками из черного металла. Открытое отделение в матовой лакировке Sabbia C07. Зеркало Square Plus в матовой лакировке Sabbia C07.

LAVADERIE LAUNDRIES

THAI

NEW COLLECTION

Maggior capacità contenitiva in funzione di un duplice utilizzo: mobile bagno e lavanderia. L'arredo è predisposto di ampie basi e colonne per contenere la lavatrice e tutto quanto il necessario in base alle esigenze pratiche di ciascuno.

Plenty of storage space for a module that doubles as a bathroom or laundry unit. The décor provides large base and tall units to hold a washing machine and everything a practical laundry needs.

TUTTO IN ORDINE

L'AMPIA COLONNA
CON APERTURA A
LIBRO È SPAZIOSA E
FUNZIONALE, PENSATA
APPOSITAMENTE PER
ACCOGLIERE GLI
ELETTRODOMESTICI.

EVERYTHING IN ITS PLACE. THE LARGE TALL
UNIT WITH HINGED DOOR, SPECIALLY
DESIGNED TO HOUSE APPLIANCES, IS ROOMY
AND PRACTICAL.

THAI **325**









THAI 325

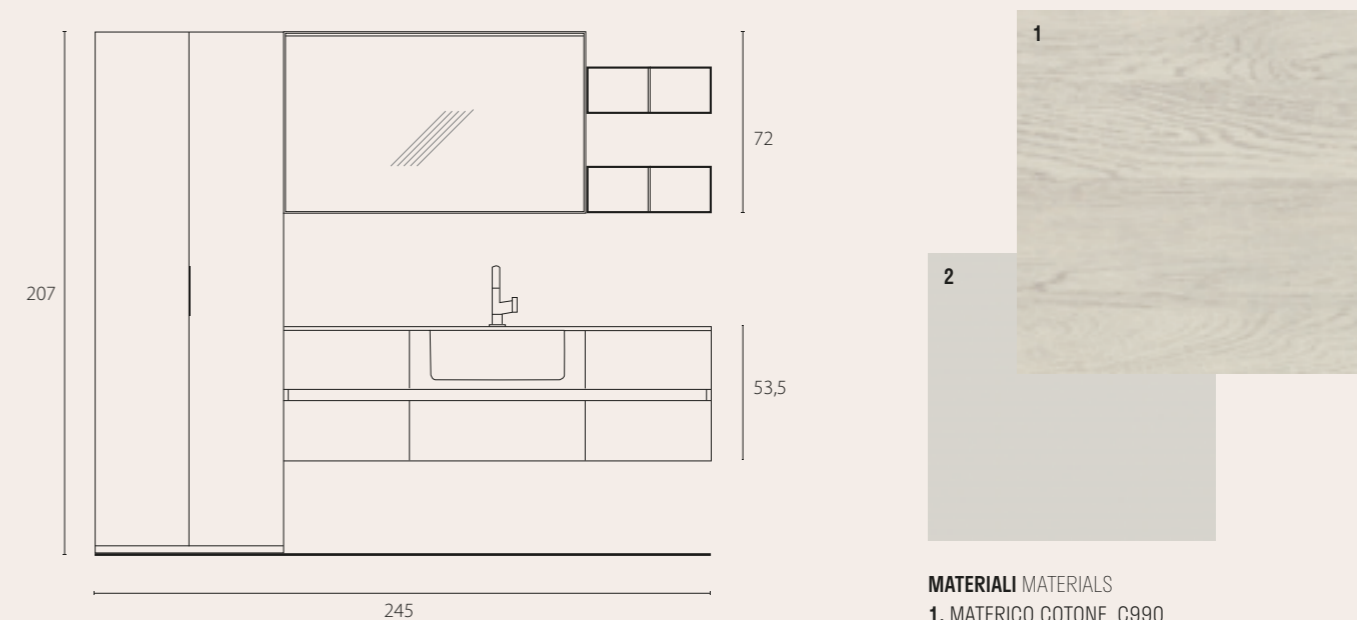

Profondità: 64/37 cm

MATERIALI MATERIALS
1. MATERICO COTONE C990
2. LACCATO OPACO SETA C32

DESCRIZIONE DESCRIPTION

Top in Tecnoril® Bianco con vasca lavatoio B500. Basi e colonna in Materico Cotone C990, gola laccato opaco nero, Maniglia in metallo nero. Pensili a giorno in metallo laccato opaco Seta C32. Specchiera con profilo alluminio spazzolato e lampada led Regolo.

EN. Top in Tecnoril® Bianco with wash tub B500. Base units and tall unit in Materico Cotone C990, grip profile in black matt lacquered, Handle in Black metal. Open wall units in matt lacquered metal Seta C32. Mirror with brushed aluminum profile and Regolo led lamp.

FR. Plan en Tecnoril® Bianco avec bac à laver B500. Élément bas et colonne en Materico Cotone C990, gorge en laqué mat noir, Poignée en métal Noir. Éléments hauts ouverts en métal laqué mat Seta C32. Miroir avec profile aluminum brossé et lampe led Regolo.

ES. Encimera de Tecnoril® Bianco con pila para lavar ropa B500. Mueble bajo y columnas de Materico Cotone C990, perfil rebajado de lacado mate Negro, Tirador de metal negro. Muebles colgantes abiertos de metal lacado mate Seta C32. Espejo con perfil aluminio cepillado y lámpara led Regolo.

DE. Waschtischplatte aus Tecnoril® Bianco mit Ausgussbecken B500. Unterschrank und Hochschranke in Materico Cotone C990, Hohlkehle in Lack Matt Schwarz, Griff aus schwarzem Metall. Offene Hängeschränke aus matt lackiertem Metall Seta C32. Spiegel mit mit gebürstetem schwarzem Profil und LED-Lampe Regolo.

RU. Столешница из Tecnoril® Bianco с раковиной B500. Нижние шкафы и высокий шкаф в отделке Materico Cotone C990. Ручка-углубление в матовой лакировке черного цвета. Черные металлические ручки. Открытые навесные шкафы из металла в матовой лакировке Seta C32. Зеркало с алюминиевым брашированным профилем, светодиодный светильник Regolo.

**UNA SOLUZIONE CHE
CONIUGA ESTETICA
E PRATICITÀ**

LA VASCA DISPONE DI
UN FONDO REMOVIBILE
CHE ALL'OCCORRENZA
SI PUÒ SPOSTARE. CON
MAGGIOR PROFONDITÀ
DIVENTA LAVATOIO.

A SOLUTION THAT COMBINES GOOD LOOKS AND
FUNCTIONALITY. THE WASH BASIN HAS A BOTTOM
THAT CAN BE MOVED TO PROVIDE MORE SPACE
AND ROOM FOR A WASH TUB.

THAI **326**









THAI 326

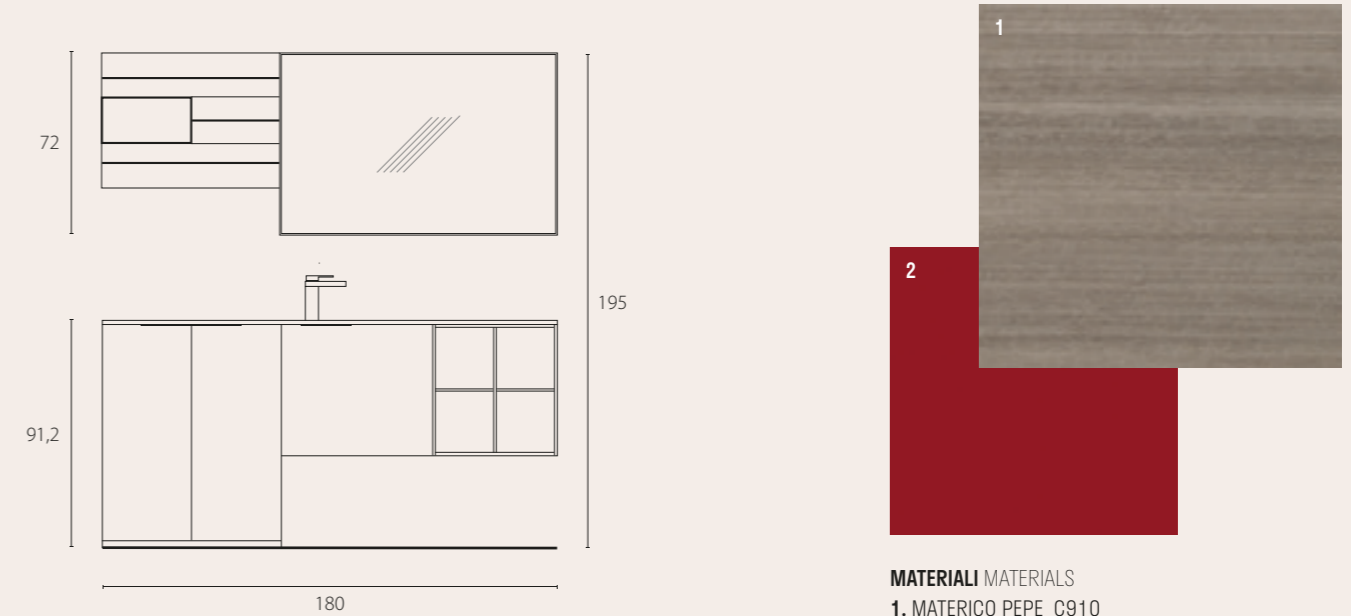

Profondità : 64/37 cm

MATERIALI MATERIALS
1. MATERICO PEPE C910
2. LACCATO OPACO RUBINO C17

DESCRIZIONE DESCRIPTION

Top in Tecnoril® bianco con vasca lavatoio B372. Basi e in Materico Pepe C980, Maniglie in metallo Titanio. Pannello in Materico Pepe C980 con mensole e vano a giorno in metallo laccato opaco Rubino C17. Specchiera Jolly con cornice Titanio e strip led.

EN. Top in Tecnoril® bianco with wash tub B372. Base units and in Materico Pepe C980, Handles in Titanio metal. Panel in Materico Pepe C980 with shelves and open compartment in matt lacquered metal Rubino C17. Jolly Mirror with Titanio frame and strip led.

FR. Plan en Tecnoril® blanc avec bac à laver B372. Élément bas and en Materico Pepe C980, Poignée en Métal Titanio. Panneau en Materico Pepe C980. Avec étagères et compartiment ouvert en métal laqué mat Rubino C17. Miroir Jolly avec cadre Titanio et strip led.

ES. Encimera de Tecnoril® blanco con pila para lavar ropa B372. Muebel bajo y de Materico Pepe C980, Tirador de Metal Titanio. Panel de Materico Pepe C980 Con estantes y compartimiento abierto de metal lacado mate Rubino C17. Espejo Jolly con marco Titanio y strip led.

DE. Waschtischplatte aus Tecnoril® Weiss mit Ausgussbecken B372. Unterschrank und in Materico Pepe C980, Griff in Metall Titanio. Platte aus Materico Pepe C980 Mit Ablagebord und offenes Fach aus matt lackiertem Metall Rubino C17. Miroir Jolly avec cadre Titanio et strip led.

RU. Столешница из Tecnoril® bianco с раковиной B372. Нижние шкафы в отделке Materico Pepe C980. Ручки из металла Titanio. Панель с полками в отделке Materico Pepe C980, полки и открытое отделение из металла в матовой лакировке Rubino C17. Зеркало Jolly в раме Titanio со светодиодной лентой.

ORGANIZZARE CON STILE

LA TEXTURE MATERICA
DELLE SUPERFICI
E GLI ELEMENTI A
GIORNO TINTA AVIO
DANNO UN TOCCO DI
ELEGANZA ALL'INTERA
COMPOSIZIONE.

ORGANISED WITH STYLE. THE SURFACE
TEXTURE AND AVIO COLOURED OPEN ELEMENTS
GIVE A TOUCH OF ELEGANCE TO THE ENTIRE
COMPOSITION.

THAI **327**







THAI 327

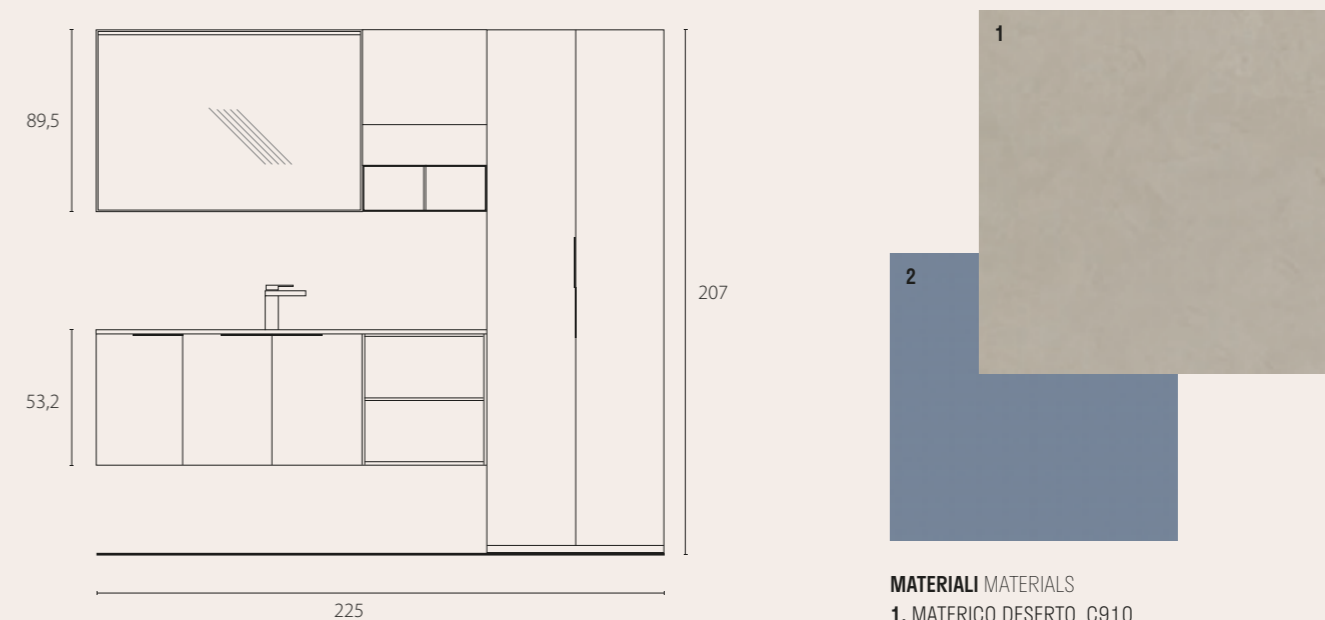

Profondità: 50 cm

MATERIALI MATERIALS
1. MATERICO DESERTO C910
2. LACCATO OPACO AVIO C42

DESCRIZIONE DESCRIPTION

Top in Tecnoril® bianco con vasca lavatoio B505. Basi, pensile e colonna in Materico Deserto C910, Maniglie in metallo Bronzo.

Base a giorno e pensile a giorno in metallo in laccato opaco Avio C42.

Specchiera con profilo in alluminio spazzolato e lampada led Konea.

EN. Top in Tecnoril® bianco with wash tub B505. Base unit, wall unit and tall unit in Materico Deserto C910, Griffe in Metall Bronze. Offene Unterschrank und Hängeschrank aus matt lackiertem Metall Avio C42. Spiegel mit gebürstetem Aluminium Profil und LED-Lampe Konea.

FR. Plan en Tecnoril® blanc avec bac à laver B505. Élément bas, haut et colonne en Materico Deserto C910, Poignées en métal Bronze. Éléments bas et haut ouverts en métal laqué mat Avio C42. Miroir avec profil aluminium brossé. Lampe led Konea.

ES. Encimera de Tecnoril® blanco con pila para lavar ropa B505. Mueble bajo, colgante y columna de Materico Deserto C910, Tiradores de metal Bronze. Mueble bajo y colgante abiertos de metal lacado mate Avio C42. Espejo con perfil aluminio cepillado Lámpara led Konea.

DE. Waschtischplatte aus Tecnoril® Weiss mit Ausgussbecken B505. Unterschrank, Hängeschrank und Hochschrank aus Materico Deserto C910, Griffe in Metall Bronze. Offene Unterschrank und Hängeschrank aus matt lackiertem Metall Avio C42. Spiegel mit gebürstetem Aluminium Profil und LED-Lampe Konea.

RU. Столешница из Tecnoril® bianco с раковиной B505. Нижние шкафы, навесной и высокий шкаф в отделке Materico Deserto C910. Ручки из металла Bronze. Открытый нижний и навесной шкаф из металла в матовой лакировке Avio C42. Зеркало в алюминиевом брашированном профиле, светодиодный светильник Konea

RAZIONALE E COMPATTA

I MODULI ESSENZIALI
SI DISPONGONO
CON EQUILIBRIO,
CONCENTRATI IN
POCO SPAZIO.

RATIONAL AND COMPACT. WHERE SPACE
IS AT A PREMIUM, ESSENTIAL MODULES
WITH BALANCED LAYOUT

THAI **328**





THAI 328

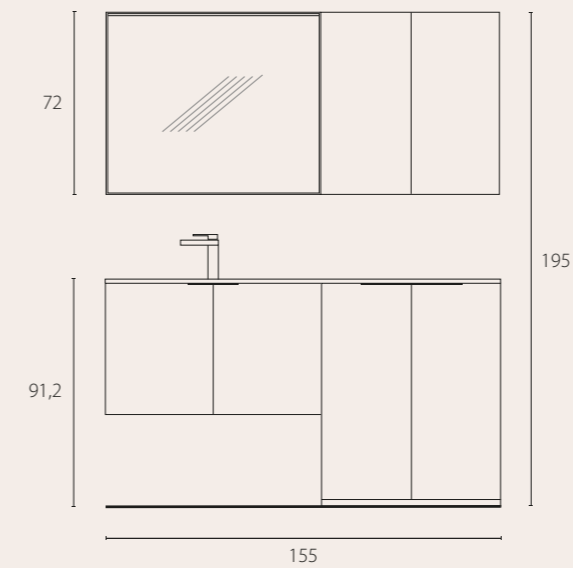

Profondità: 50/64 cm



MATERIALI MATERIALS
1. LACCATO OPACO SENAPE C38

DESCRIZIONE DESCRIPTION

Top in Tecnoril® Bianco con vasca lavatoio B505. Basi in laccato opaco Senape C38. Maniglie in metallo Argento. Specchio contenitore laccato opaco Senape C38. Specchiera con profilo alluminio spazzolato e lampada led Konea.

EN. Top in Tecnoril® Bianco with wash tub B505. Base units in matt lacquered Senape C38. Handles in Silver metal. Mirror cabinet in matt lacquered Senape C38. Konea Led lamp.

FR. Plan en Tecnoril® Bianco avec bac à laver B505. Eléments bas en laqué mat Senape C38. Poignées en métal Argent. Miroir rangement en laqué mat Senape C38. Lampe led Konea.

ES. Encimera de Tecnoril® Blanco con pila para lavar ropa B505. Muebles bajos de lacado mate Senape C38. Tiradores de metal de plata. Espejo contenedor de lacado mate Senape C38. Lámpara led Konea.

DE. Waschtischplatte aus Tecnoril® Bianco mit Ausgussbecken B505. Unterschränke in Lack Matt Senape C38. Griff in Metall Silber. Spiegelschrank in Lack Matt Senape C38. LED-Lampe Konea.

RU. Столешница из Tecnoril® Bianco с раковиной B505. Нижние шкафы в матовой лакировке Senape C38. Ручки из металла Argento. Зеркало-шкаф в матовой лакировке Senape C38. Зеркало в алюминиевом брашированном профиле, светодиодный светильник Konea.

THAI
MATERICI



C900 TALCO



C910 DESERTO

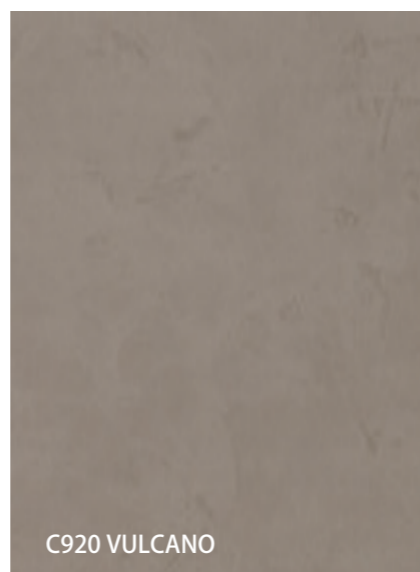

C920 VULCANO



C930 BASALTO



C940 LINO



C950 VISONE



C960 CARBONE



C970 CANNELLA



C980 PEPE



C990 COTONE



C330 PAPAVERO

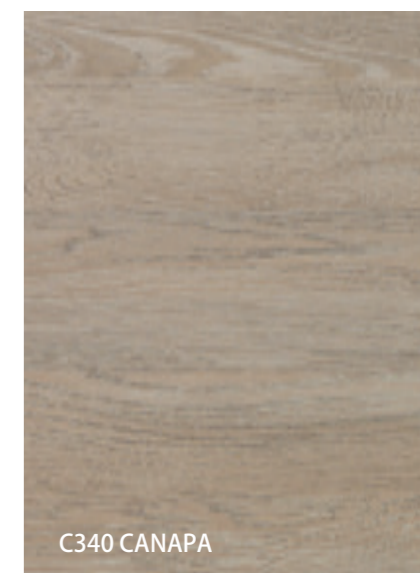

C340 CANAPA

THAI LACCATI LUCIDI E OPACHI

GLOSSY AND MATT LACQUERED
 LAQUÉS BRILLANTS ET MATS
 LACADOS BRILLANTES Y OPACOS
 LACK HOCHGLANZ UND MATT
 ГЛЯНЦЕВАЯ И МАТОВАЯ ЛАКИРОВКА

BIANCO	PANNA	SETA	ECRÙ	SABBIA	CORDA
CEMENTO	ARDESIA	GRAFITE	CENERE		
BURRO	CREMA	CAPPUCCINO	CACAO		
CRETA	TERRA	BOSCO	ARGILLA	FANGO	LAVAGNA
ROSA	ARANCIO	FRAGOLA	CORALLO	RUBINO	
ANICE	LILLA	CICLAMINO	VINACCIA		
SENAPE	MELA	PISTACCHIO			
AZZURRO	GHIACCIO	AVIO	NETTUNO	BLU PACIFICO	
SABBIA METAL.	PERLA METAL.	NERO			

Thanks to:
ZUCCHETTI RUBINETTERIE S.P.A.
LAMINAM

Design **UFFICIO TECNICO RAB**,
A.D. **MAURA SANTAROSSA** con la collaborazione di Michele Guerra e Alessandro Paolin
Graphic **LISA LONGO**, Colour separation and Print **IMOCO**

Printed Settembre 2018

PER LA REALE TONALITÀ DEI COLORI FARE RIFERIMENTO AL CAMPIONARIO. LE IMMAGINI E I DATI CONTENUTI NEL PRESENTE CATALOGO SONO DA RITENERSI INDICATIVI E POSSONO SUBIRE VARIAZIONI ANCHE SENZA PREAVVISO.

FOR THE REAL COLOR SHADE, SEE RAB COLOR CHART. IMAGES AND DATA CONTAINED IN THIS CATALOGUE ARE TO BE CONSIDERED INDICATIVE AND MAY BE CHANGED WITHOUT ANY NOTICE.

FÜR DIE TATSÄCHLICHEN FARBTÖNE SEHEN SIE BITTE IN UNSEREM MUSTERBUCH NACH. DIE IN DIESEM KATALOG ENTHALTENEN BILDER UND DATEN HABEN NUR UNGEFÄHREN CHARAKTER UND KÖNNEN AUCH OHNE VORHERIGE MITTEILUNG ÄNDERUNGEN UNTERLIEGEN.

CONSULTER LE CATALOGUE DES ÉCHANTILLONS POUR LA NUANCE EXACTE DES COULEURS. LES IMAGES ET LES DONNÉES CONTENUES DANS LE PRÉSENT CATALOGUE DOIVENT ÊTRE CONSIDÉRÉES COMME INDICATIVES, ELLES PEUVENT SUBIR DES VARIATIONS SANS AUCUN PRÉAVIS.

PARA EL TONO REAL DE LOS COLORES TOMAR COMO REFERENCIA EL MUESTRARIO. LAS IMÁGENES Y LOS DATOS CONTENIDOS EN ESTE CATÁLOGO SON SOLO INDICATIVOS Y PUEDEN SUFRIR VARIACIONES INCLUSO SIN PREAVISO.

ДЛЯ ОПРЕДЕЛЕНИЯ ФАКТИЧЕСКИХ ЦВЕТОВЫХ ОТТЕНКОВ, РУКОВОДСТВУЙТЕСЬ ПРИЛАГАЕМОЙ ПАЛИТРОЙ ЦВЕТОВ В ОБРАЗЦАХ. ИЗОБРАЖЕНИЯ И ДАННЫЕ, ПРИВЕДЕННЫЕ В ДАННОМ КАТАЛОГЕ, ЯВЛЯЮТСЯ ЧИСТО ОРИЕНТИРОВОЧНЫМИ И МОГУТ ПОДВЕРГАТЬСЯ ИЗМЕНЕНИЯМ, В ТОМ ЧИСЛЕ, БЕЗ ПРЕДВАРИТЕЛЬНОГО ПРЕДУПРЕЖДЕНИЯ.

RAB[®]
DESIGN FOR BATHROOMS

www.rabarredobagno.com - info@rabarredobagno.com